

MTH PUMPS

140 • 240 • 180 • 280 Series

- Capacities to 60 GPM
- Heads to 800 Feet
- Low NPSH Requirements
- Flex Coupled

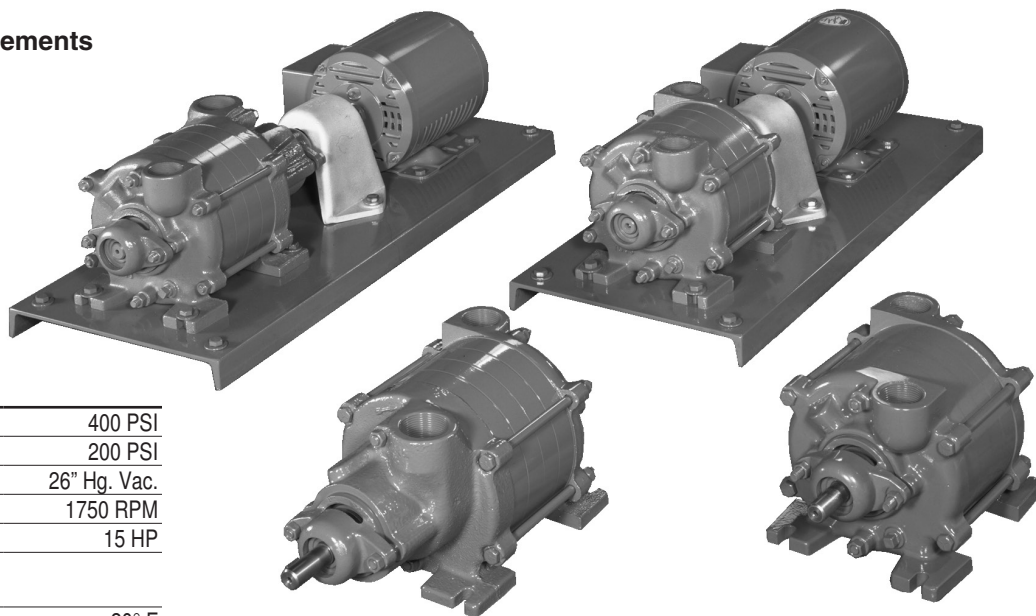

LIMITATIONS

Discharge Pressure	400 PSI
Seal Pressure*	200 PSI
Suction Pressure (Min.)	26" Hg. Vac.
Speed	1750 RPM
Horsepower	15 HP

Temperature

Standard Construction	-20° F
Ceramic Seal Seat - Water	+230° F
Ni-Resist Seal Seat - Water	+230° F
Silicon Carbide Seal Seat & External Seal Flush	+250° F

* Suction Pressure Plus a Percentage of Differential Pressure

LOW NPSH

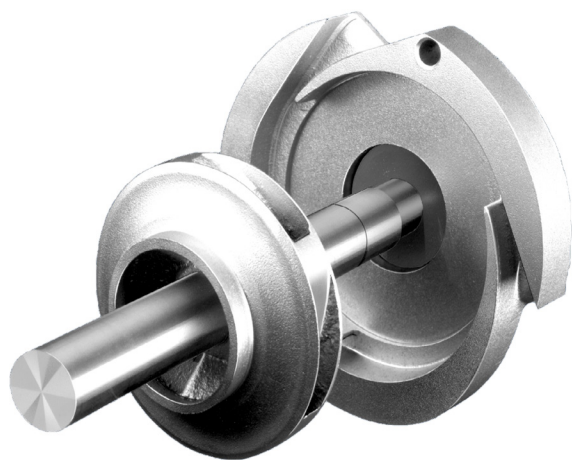
200 Series Inducer

The 200 Series inducer style pumps are ideally suited to applications where available NPSH at the pump inlet is limited, such as boiler feed water deaerator service. A centrifugal Francis vane impeller with low NPSH characteristics is utilized as the pump's first stage impeller, accounting for the lower inlet head requirement. This first stage impeller is used in conjunction with a multi-vane diffuser to provide the NPSH required by the second stage regenerative turbine. Available NPSH as low as two feet can be effectively handled with 240 • 280 Series pumps, depending on the pump model and capacity.



MTH PUMPS

401 West Main Street • Plano, IL 60545-1436
 Phone: 630-552-4115 • Fax: 630-552-3688
 Email: SALES@MTHPUMPS.COM
<http://WWW.MTHPUMPS.COM>

140 • 240 • 180 • 280 SERIES

Selection Chart

U.S. GALLONS PER MINUTE

HEAD IN FEET	4 Model HP	5 Model HP	6 Model HP	8 Model HP	10 Model HP	12 Model HP	15 Model HP	20 Model HP	25 Model HP	30 Model HP	40 Model HP	50 Model HP
25	*	*	*	141D .5	141E .5	141F .5	141G .5	141H .75	141I .75	141IA 1	181M 1.5	181P 1.5
50	*	*	141D .5	141E .5	141F .5	141G .5	141H .75	141I 1	181K 1	181M 1.5	181P 1.5	181R 2
75	*	*	141D .5	141E .5	141F .75	142F .75	141H 1	141I 1	141IA 1.5	181M 2	181R 3	182R 5
100	*	141D .5	141E .5	141F .75	142F .75	141H 1	141I 1	141IA 1.5	182K 2	181P 2	182P 3	183R 5
125	141D .75	141E .75	141E .75	141G 1	142F 1	142G 1.5	142H 1.5	142I 2	182K 2	182M 3	182P 3	183R 5
150	141E .75	141E .75	142D 1	143E 1	142G 1.5	143G 1.5	142H 2	143I 3	142IA 3	182M 5	182R 5	184R 7.5
175	141E 1	142D 1	142E 1	142F 1.5	142G 1.5	142H 2	142I 2	182K 3	143IA 3	182P 5	183P 5	**
200	141E 1	142D 1	142E 1	142F 1.5	143F 1.5	142H 2	142I 3	142IA 3	183K 3	183M 5	183R 7.5	**
225	142D 1.5	143D 1.5	142E 1.5	142F 1.5	143G 2	143H 3	142I 3	142IA 3	143IA 5	183P 5	184P 7.5	**
250	142D 1.5	143D 1.5	142E 1.5	143F 2	143G 2	143H 3	143I 3	143IA 5	144IA 5	183P 5	184R 10	**
300	143D 1.5	142E 1.5	143E 1.5	143F 2	143H 3	142I 3	143I 5	143IA 5	183P 7.5	184P 7.5	**	**
350	144D 2	144D 2	143E 2	144F 3	144H 5	144H 5	143I 5	144IA 5	184M 7.5	184P 7.5	**	**
400	144D 2	143E 2	144E 2	144G 3	144H 5	143I 5	144I 5	144IA 5	184P 7.5	**	**	**
450	144D 2	143E 2	144E 2	144G 3	143I 5	144I 5	183K 7.5	184P 10	184R 15	**	**	**
500	144D 3	144E 3	144F 3	143I 5	143I 7.5	144I 7.5	144IA 7.5	**	**	**	**	**
550	143E 3	144E 3	143I 5	143I 5	144I 7.5	144IA 7.5	**	**	**	**	**	**
600	144E 3	144G 5	143I 7.5	144I 7.5	144I 7.5	144IA 7.5	**	**	**	**	**	**
650	144E 3	**	**	**	**	**	**	**	**	**	**	**
700	144E 3	**	**	**	**	**	**	**	**	**	**	**

140 • 240 SERIES PUMPS

NOTES

Selections based on cold water flooded suction 1.0 S.G. Open Drip Proof Motor.
 Consult individual pump curve for final selection.
 *Refer to T31 • T41 • T51 Series Curves
 **Refer to 150 • 250 • 160 • 260 • 170 • 270 Series Selection chart



MTH PUMPS

401 West Main Street • Plano, IL 60545-1436
 Phone: 630-552-4115 • Fax: 630-552-3688
 Email: SALES@MTHPUMPS.COM
<http://WWW.MTHPUMPS.COM>



WARNING:
 CANCER AND REPRODUCTIVE HARM
WWW.P65WARNINGS.CA.GOV



MTH PUMPS

401 West Main Street • Plano, IL 60545-1436
Phone: 630-552-4115 • Fax: 630-552-3688
Email: SALES@MTHPUMPS.COM
<http://WWW.MTHPUMPS.COM>



WARNING:
CANCER AND REPRODUCTIVE HARM
WWW.P65WARNINGS.CA.GOV

140 • 240 • 180 • 280 SERIES

Performance Curves

140D & 240D*

1750 RPM

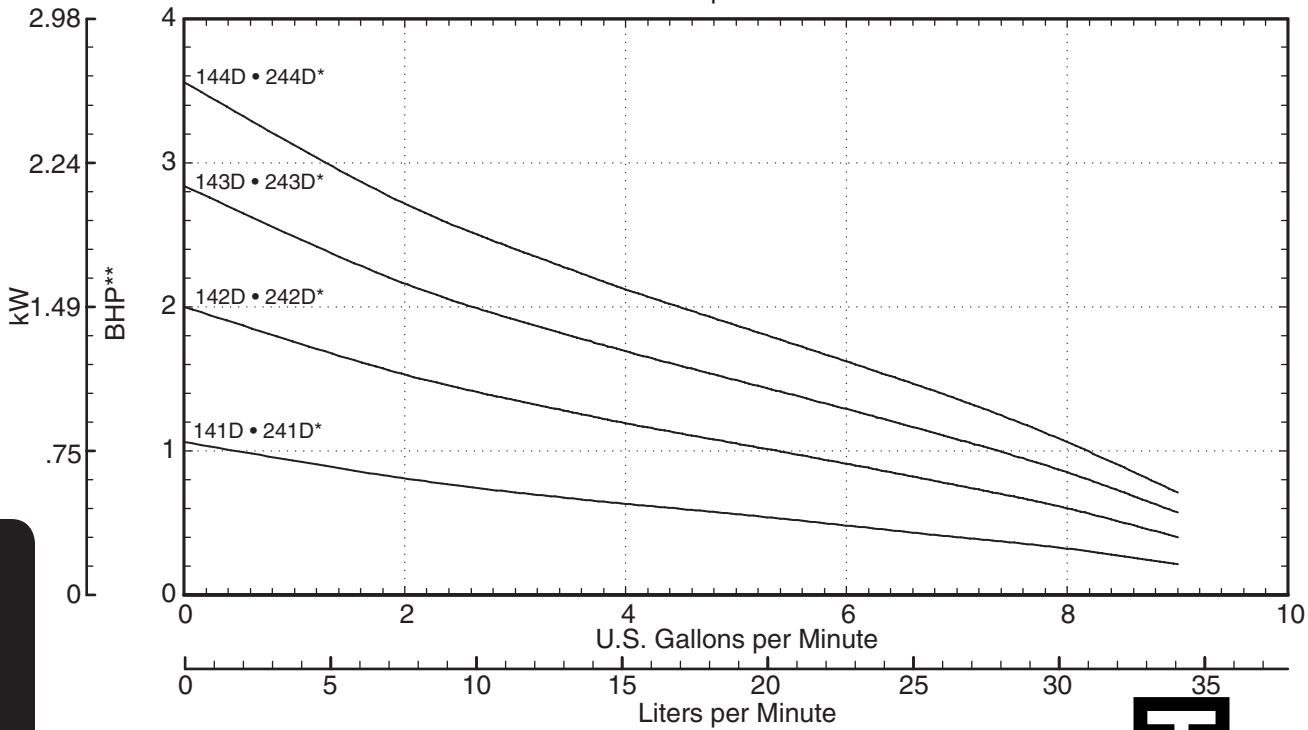
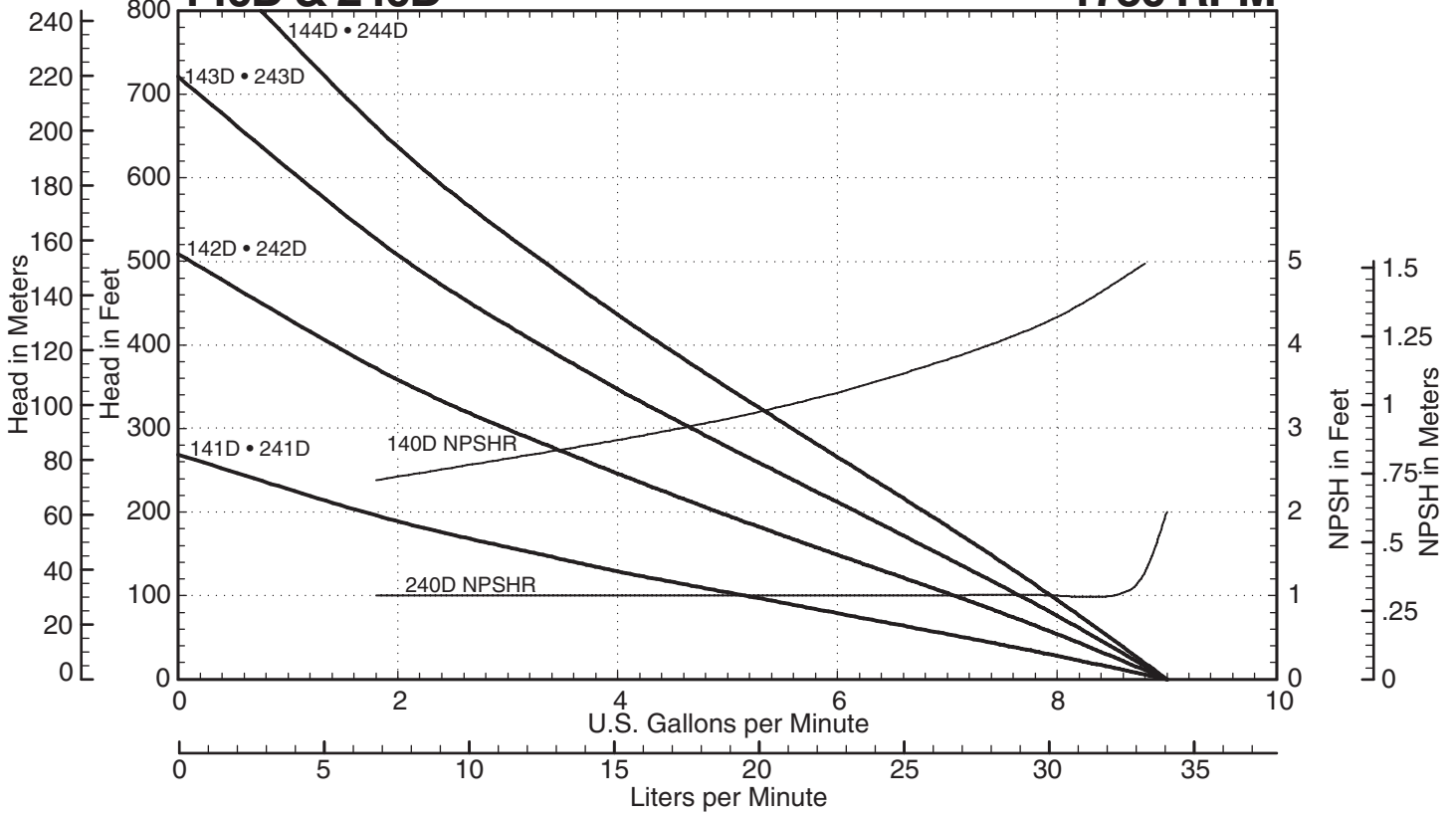

140 • 240 SERIES PUMPS

NOTES

Consult factory for operation below 1.5 GPM
 *Add 1/2 horsepower for 240 Series models
 **Horsepower data is valid for 1.0 specific gravity fluids only



401 West Main Street • Plano, IL 60545-1436
 Phone: 630-552-4115 • Fax: 630-552-3688
 Email: SALES@MTHPUMPS.COM
 http://WWW.MTHPUMPS.COM



140 • 240 • 180 • 280 SERIES

Performance Curves

140D & 240D*

1450 RPM

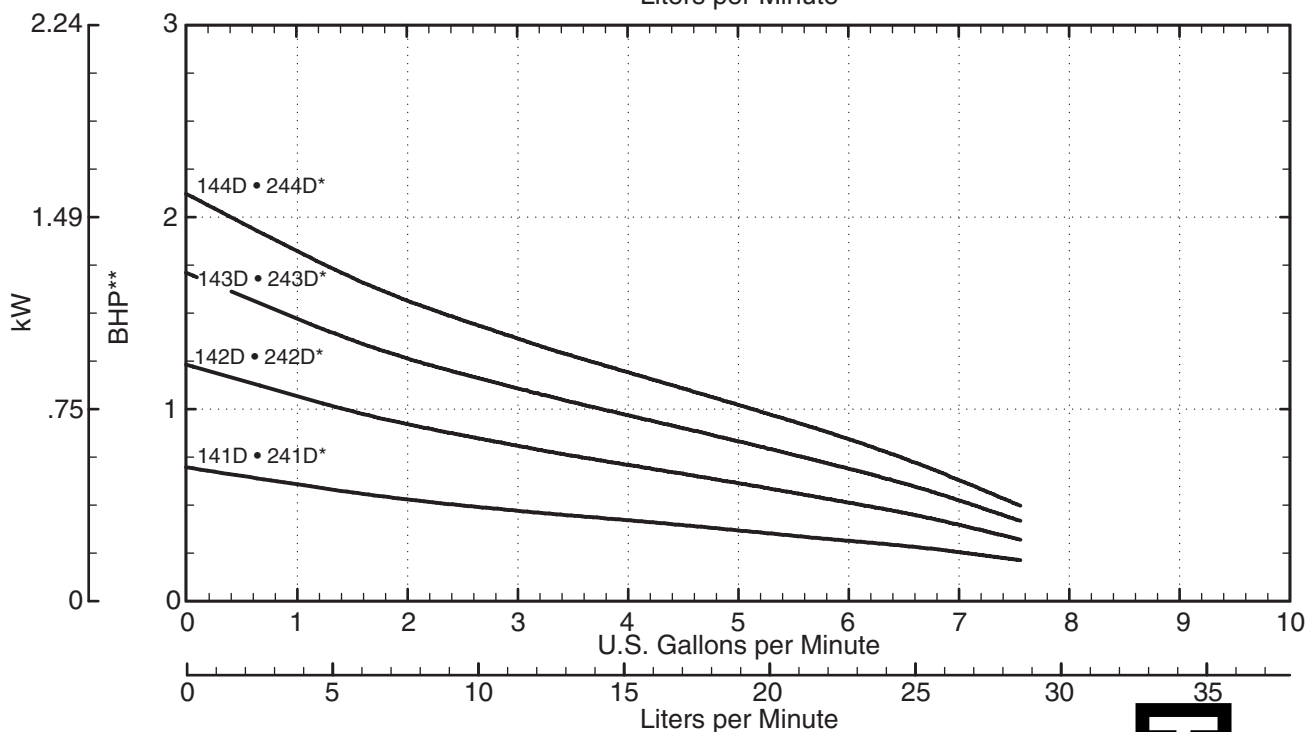
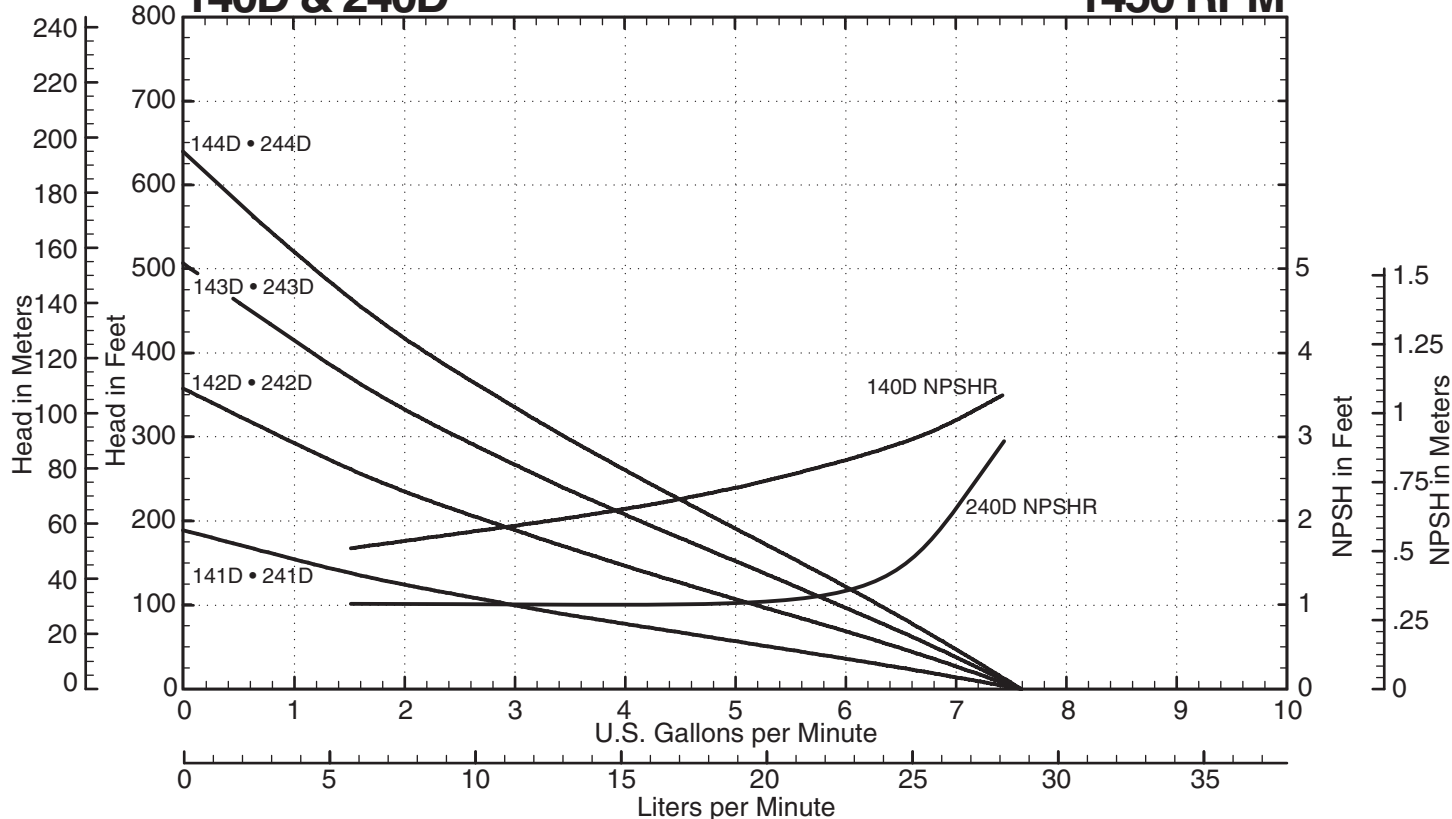

NOTES

- Consult factory for operation below 1.5 GPM
- *Add 1/2 horsepower for 240 Series models
- **Horsepower data is valid for 1.0 specific gravity fluids only



401 West Main Street • Plano, IL 60545-1436
 Phone: 630-552-4115 • Fax: 630-552-3688
 Email: SALES@MTHPUMPS.COM
 http://WWW.MTHPUMPS.COM

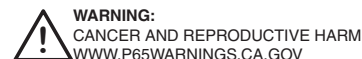

140 • 240 SERIES PUMPS

140 • 240 • 180 • 280 SERIES

Performance Curves

140E & 240E*

1750 RPM

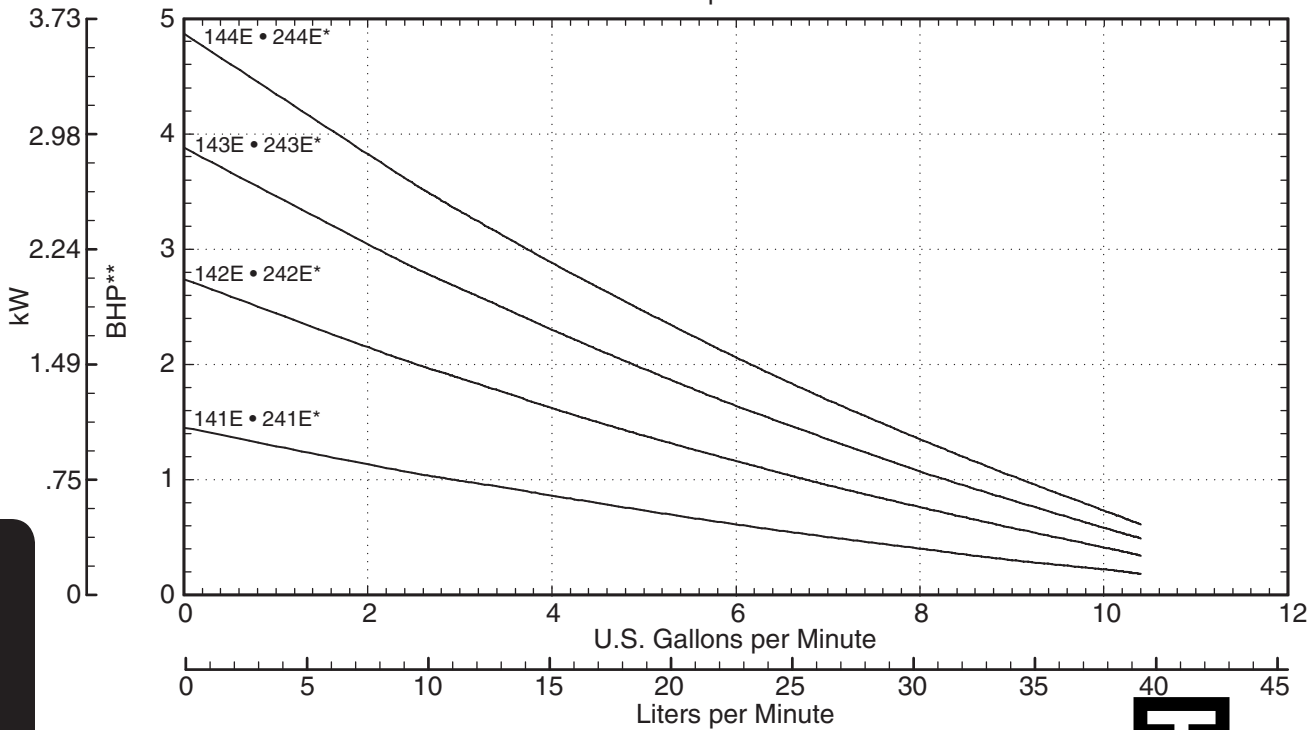
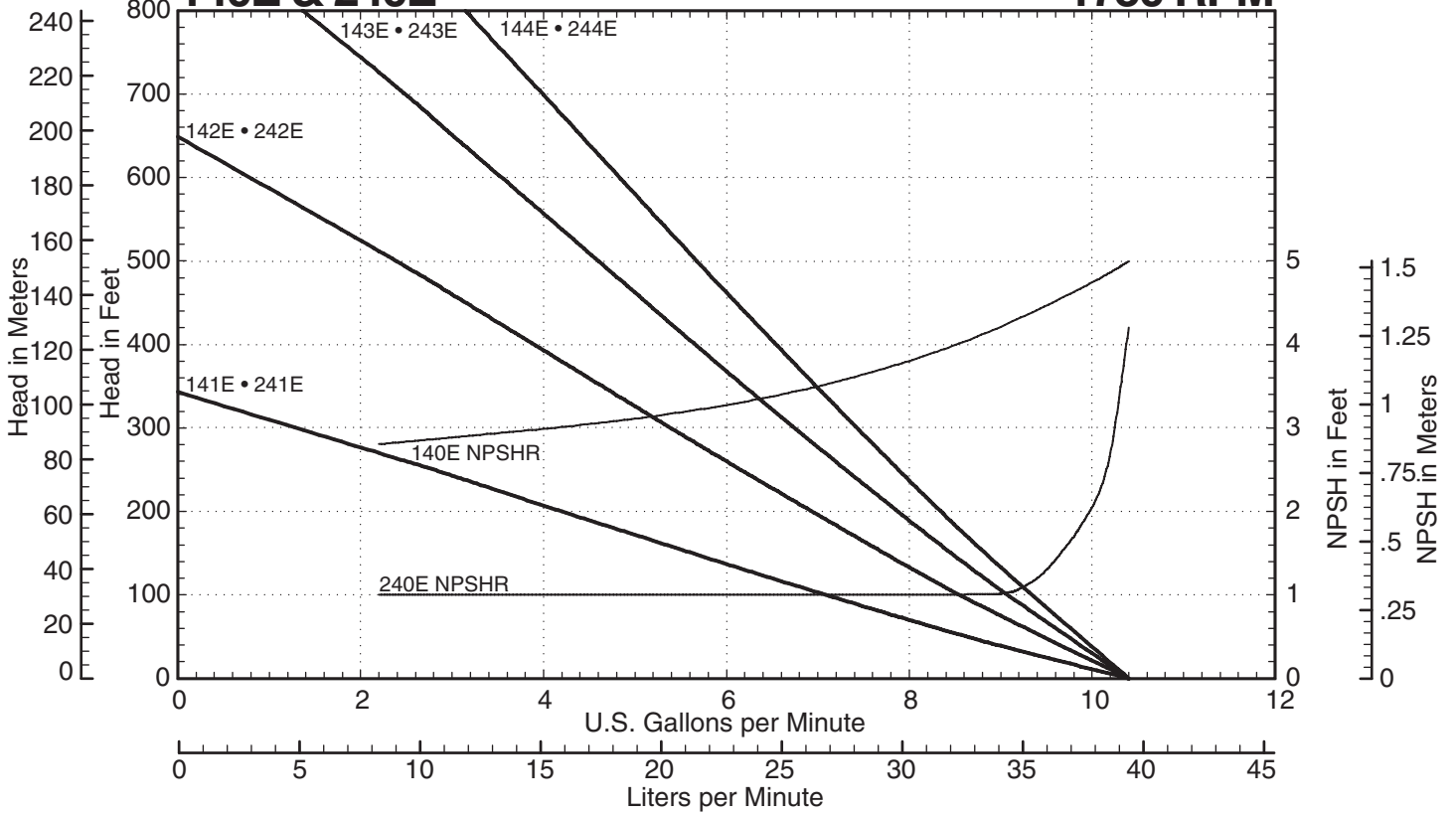

140 • 240 SERIES PUMPS

NOTES

- Consult factory for operation below 1.5 GPM
- *Add 1/2 horsepower for 240 Series models
- **Horsepower data is valid for 1.0 specific gravity fluids only



401 West Main Street • Plano, IL 60545-1436
 Phone: 630-552-4115 • Fax: 630-552-3688
 Email: SALES@MTHPUMPS.COM
 http://WWW.MTHPUMPS.COM



140 • 240 • 180 • 280 SERIES

Performance Curves

140E & 240E*

1450 RPM

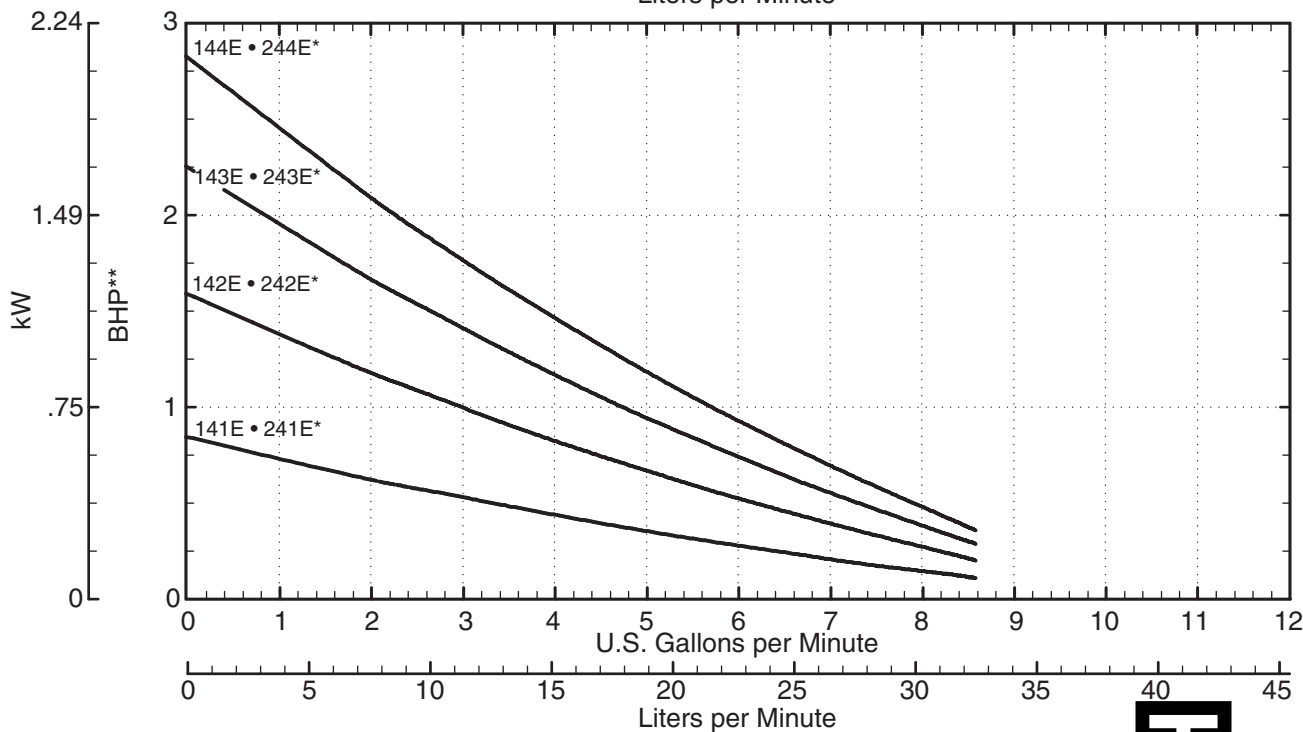
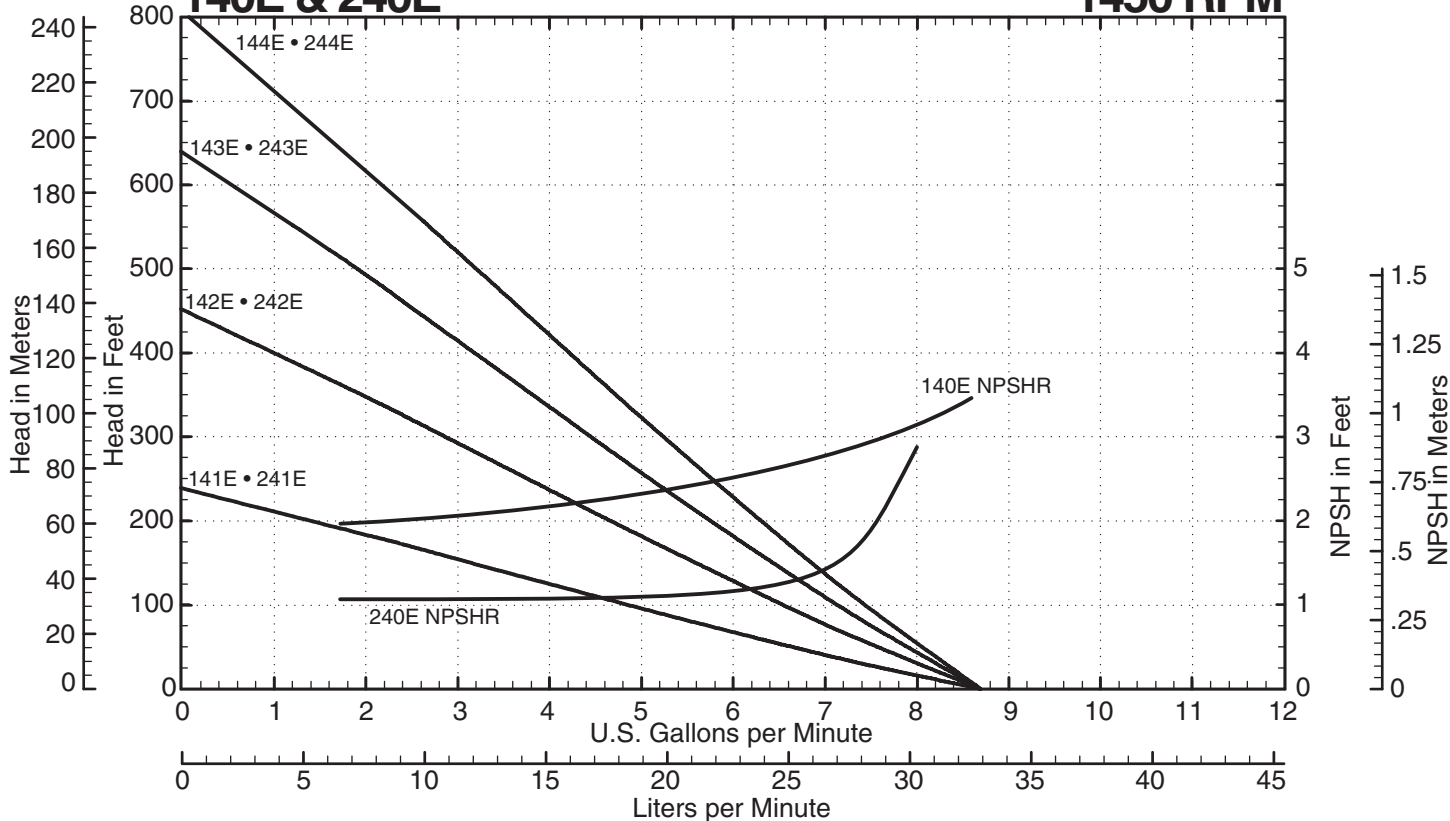

NOTES

- Consult factory for operation below 1.5 GPM
- *Add 1/2 horsepower for 240 Series models
- **Horsepower data is valid for 1.0 specific gravity fluids only



401 West Main Street • Plano, IL 60545-1436
 Phone: 630-552-4115 • Fax: 630-552-3688
 Email: SALES@MTHPUMPS.COM
 http://WWW.MTHPUMPS.COM

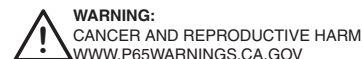

140 • 240 SERIES PUMPS

140 • 240 • 180 • 280 SERIES

Performance Curves

140F & 240F*

1750 RPM

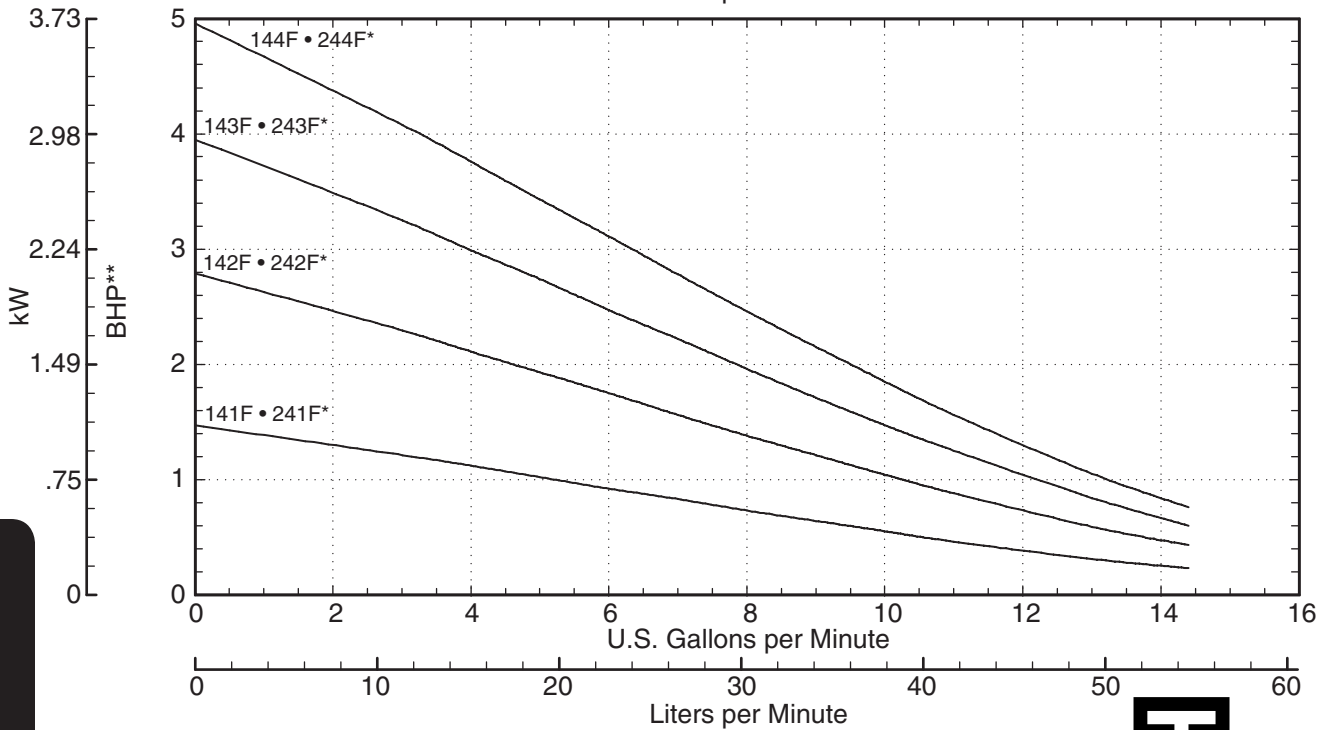
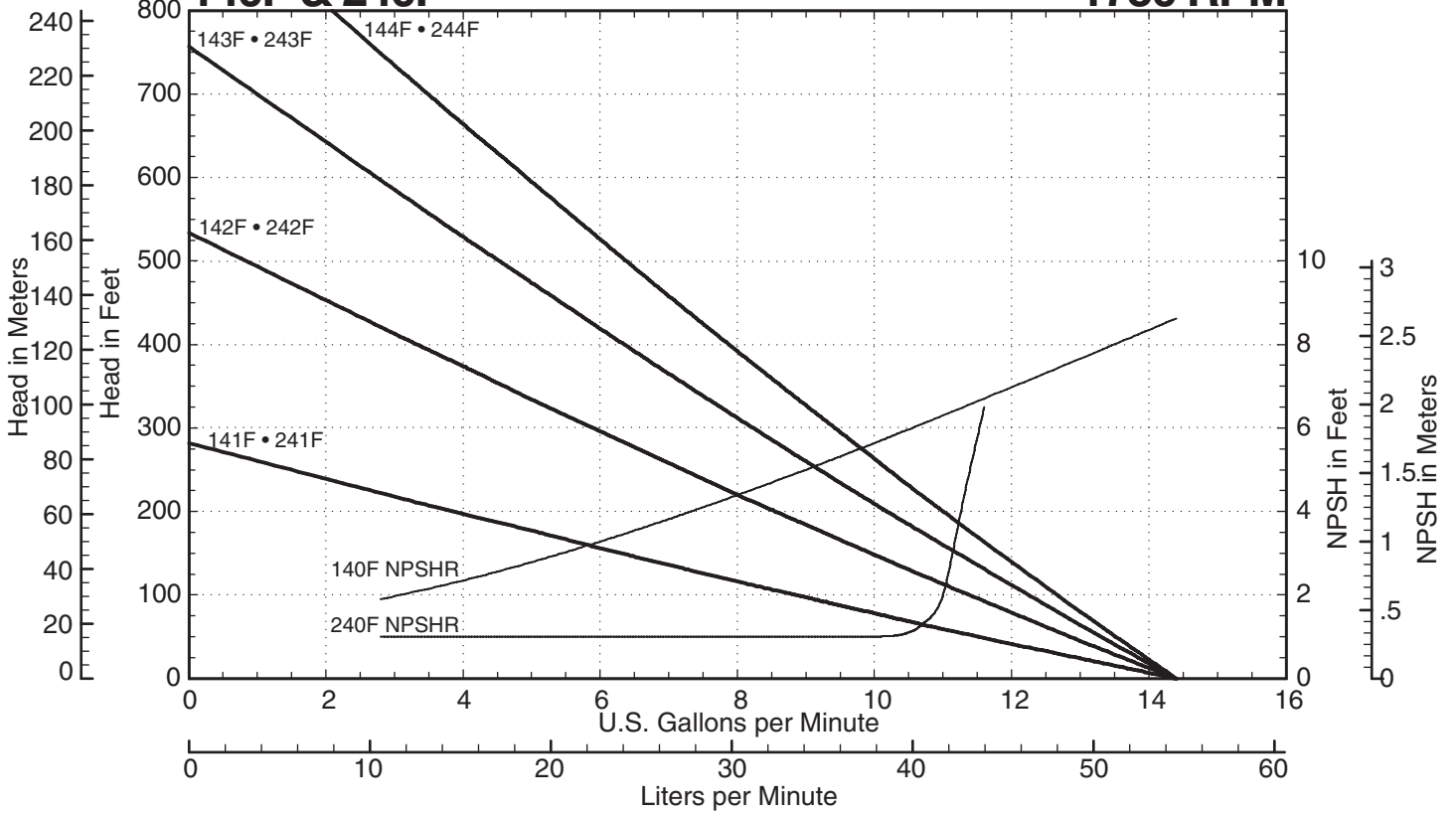

140 • 240 SERIES PUMPS

NOTES

- Consult factory for operation below 2 GPM
- *Add 1/2 horsepower for 240 Series models
- **Horsepower data is valid for 1.0 specific gravity fluids only



401 West Main Street • Plano, IL 60545-1436
 Phone: 630-552-4115 • Fax: 630-552-3688
 Email: SALES@MTHPUMPS.COM
 http://WWW.MTHPUMPS.COM



140 • 240 • 180 • 280 SERIES

Performance Curves 140F & 240F*

1450 RPM

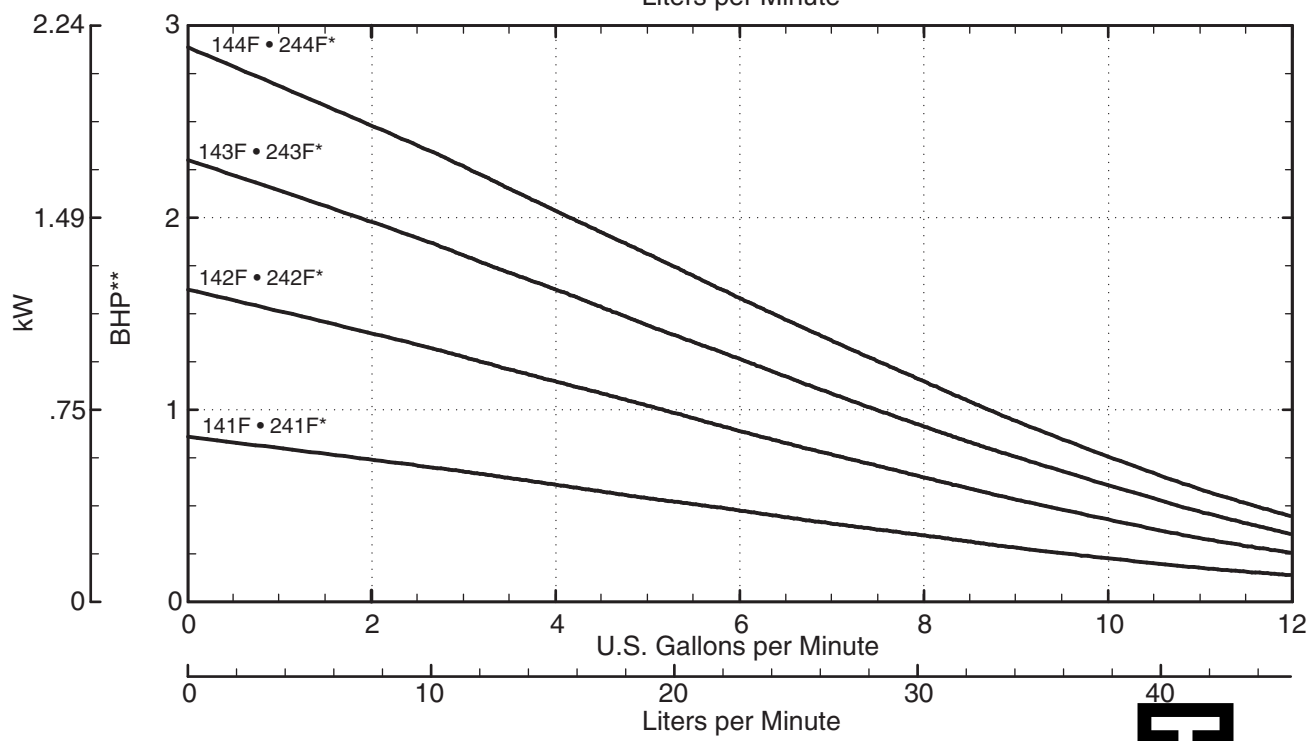
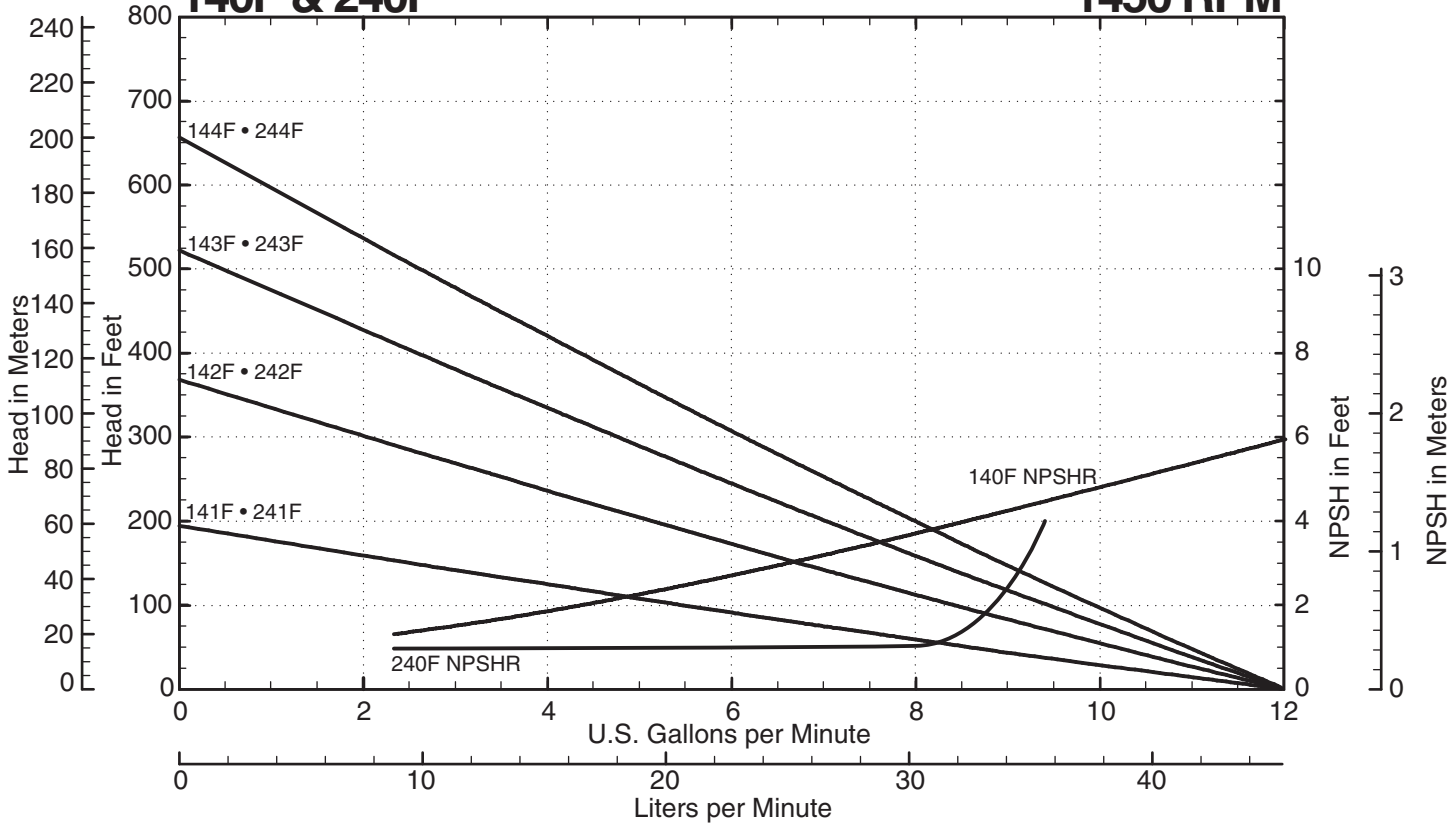

NOTES
 Consult factory for operation below 2 GPM
 *Add 1/2 horsepower for 240 Series models
 **Horsepower data is valid for 1.0 specific gravity fluids only

MTH PUMPS
 401 West Main Street • Plano, IL 60545-1436
 Phone: 630-552-4115 • Fax: 630-552-3688
 Email: SALES@MTHPUMPS.COM
 http://WWW.MTHPUMPS.COM

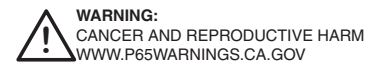

140 • 240 SERIES PUMPS

140 • 240 • 180 • 280 SERIES

Performance Curves

140G & 240G*

1750 RPM

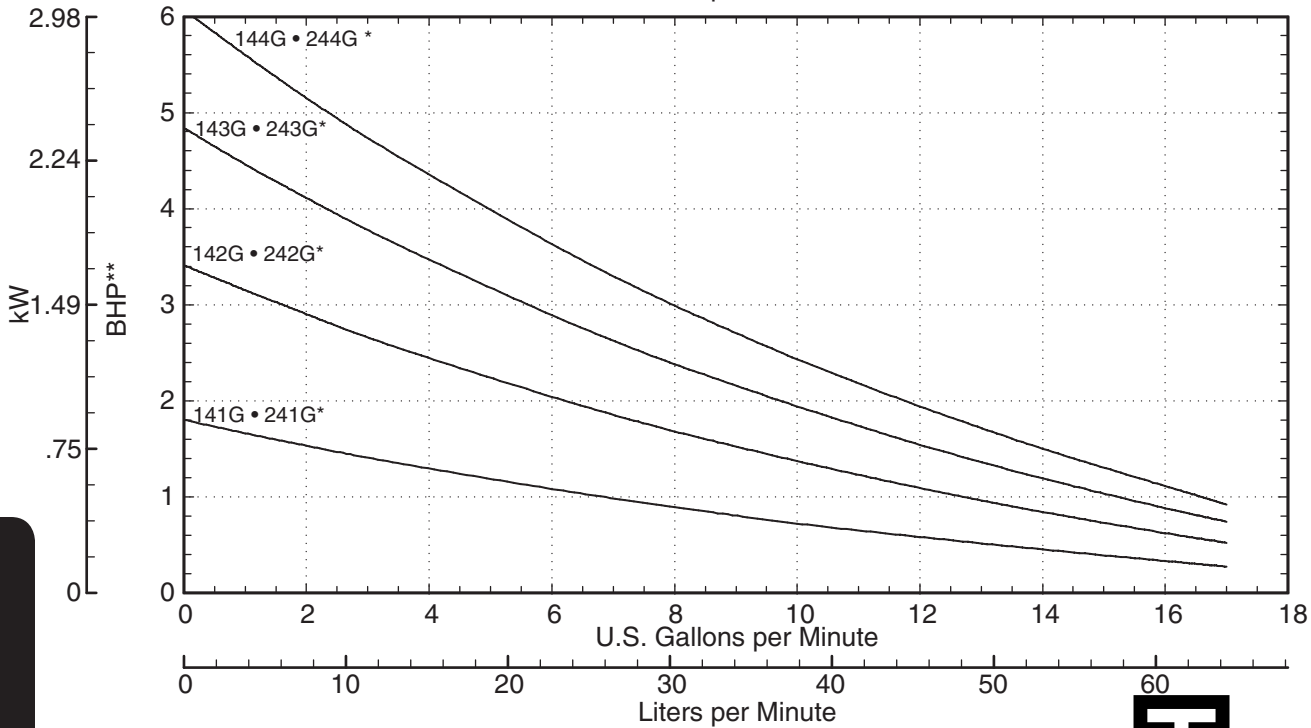
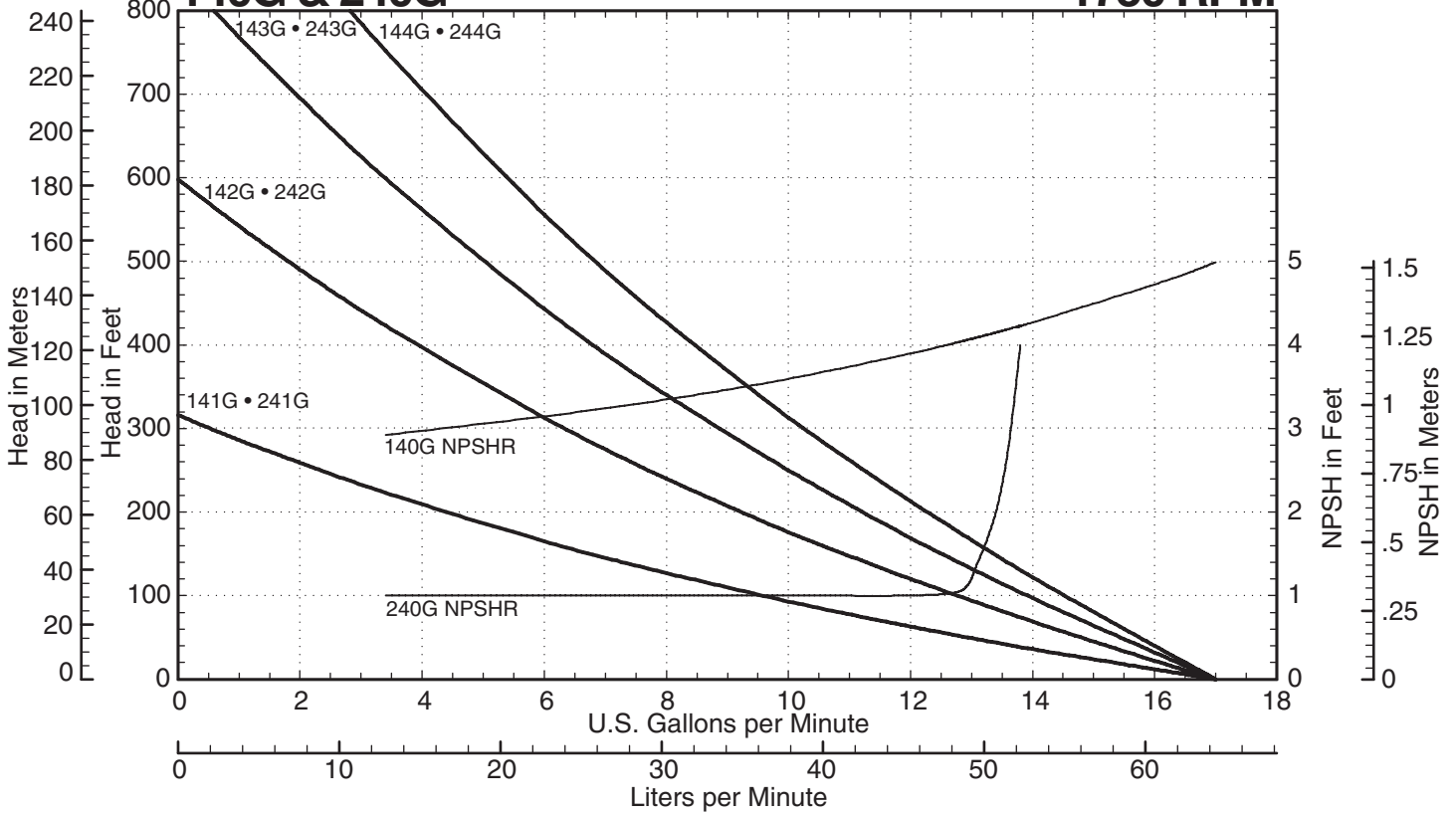

140 • 240 SERIES PUMPS

NOTES

Consult factory for operation below 2.5 GPM

*Add 1/2 horsepower for 240 Series models

**Horsepower data is valid for 1.0 specific gravity fluids only



MTH PUMPS

401 West Main Street • Plano, IL 60545-1436

Phone: 630-552-4115 • Fax: 630-552-3688

Email: SALES@MTHPUMPS.COM

http://WWW.MTHPUMPS.COM



WARNING:

CANCER AND REPRODUCTIVE HARM
WWW.P65WARNINGS.CA.GOV

140 • 240 • 180 • 280 SERIES

Performance Curves 140G & 240G*

1450 RPM

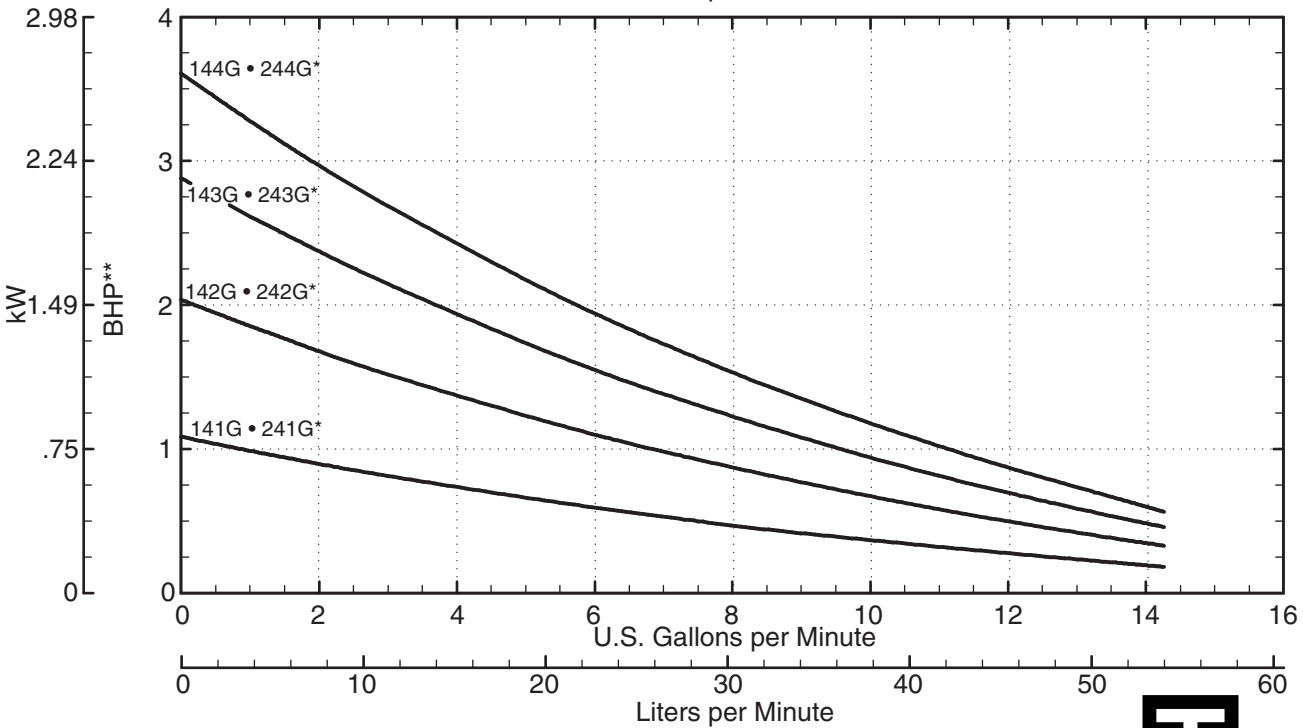
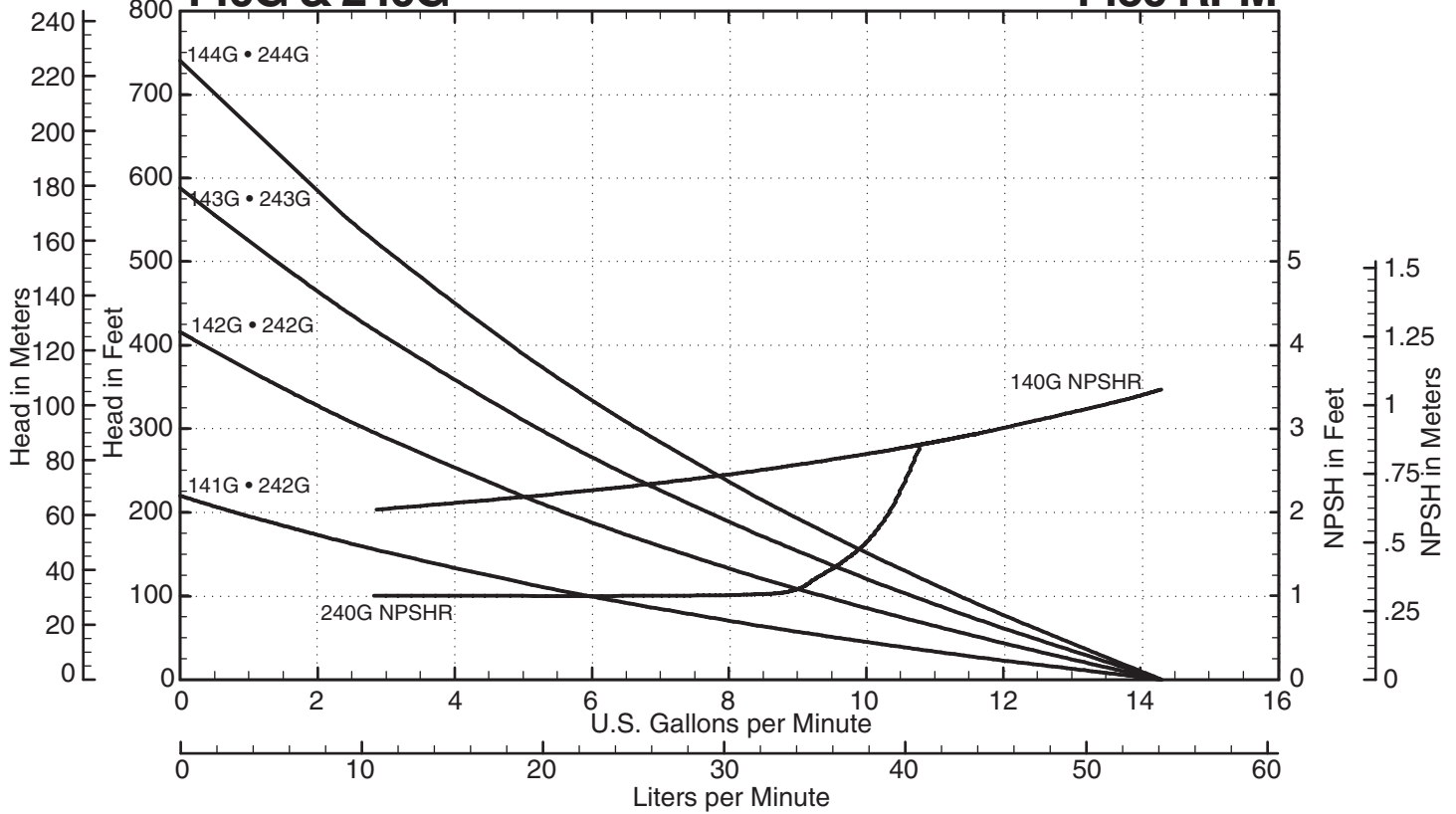

NOTES

- Consult factory for operation below 2.5 GPM
- *Add 1/2 horsepower for 240 Series models
- **Horsepower data is valid for 1.0 specific gravity fluids only

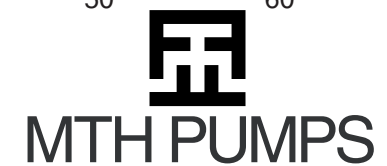

401 West Main Street • Plano, IL 60545-1436
 Phone: 630-552-4115 • Fax: 630-552-3688
 Email: SALES@MTHPUMPS.COM
 http://WWW.MTHPUMPS.COM



140 • 240 • 180 • 280 SERIES

Performance Curves 140H & 240H*

1750 RPM

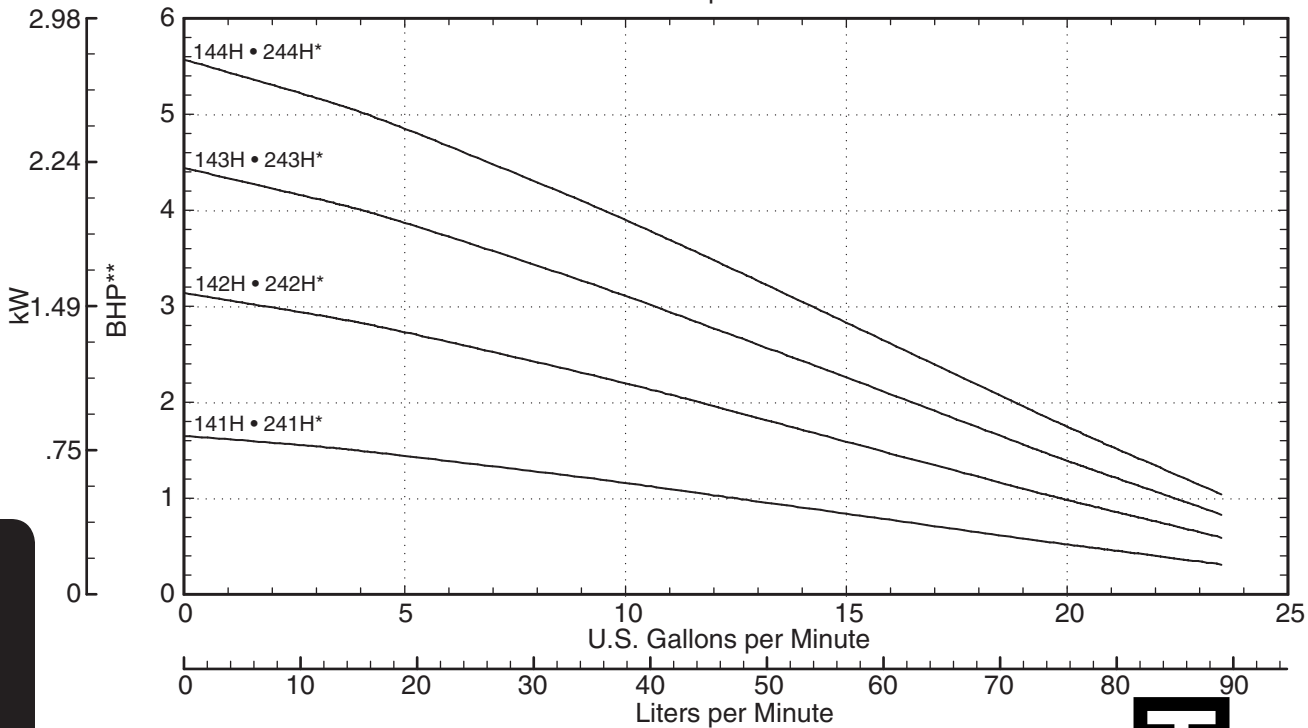
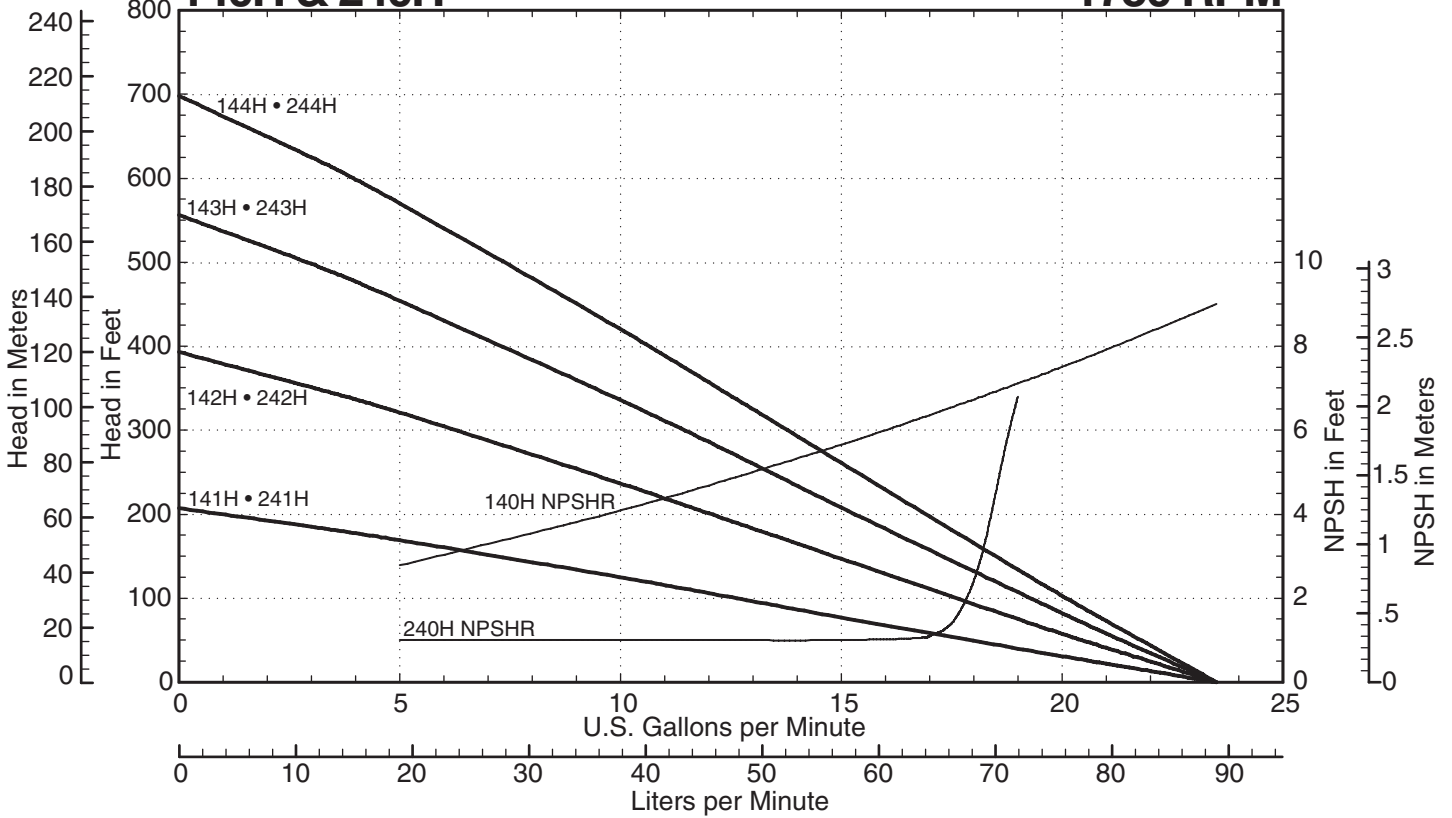

140 • 240 SERIES PUMPS

NOTES

- Consult factory for operation below 3 GPM
- *Add 1/2 horsepower for 240 Series models
- **Horsepower data is valid for 1.0 specific gravity fluids only



MTH PUMPS
 401 West Main Street • Plano, IL 60545-1436
 Phone: 630-552-4115 • Fax: 630-552-3688
 Email: SALES@MTHPUMPS.COM
 http://WWW.MTHPUMPS.COM



140 • 240 • 180 • 280 SERIES

Performance Curves 140H & 240H*

1450 RPM

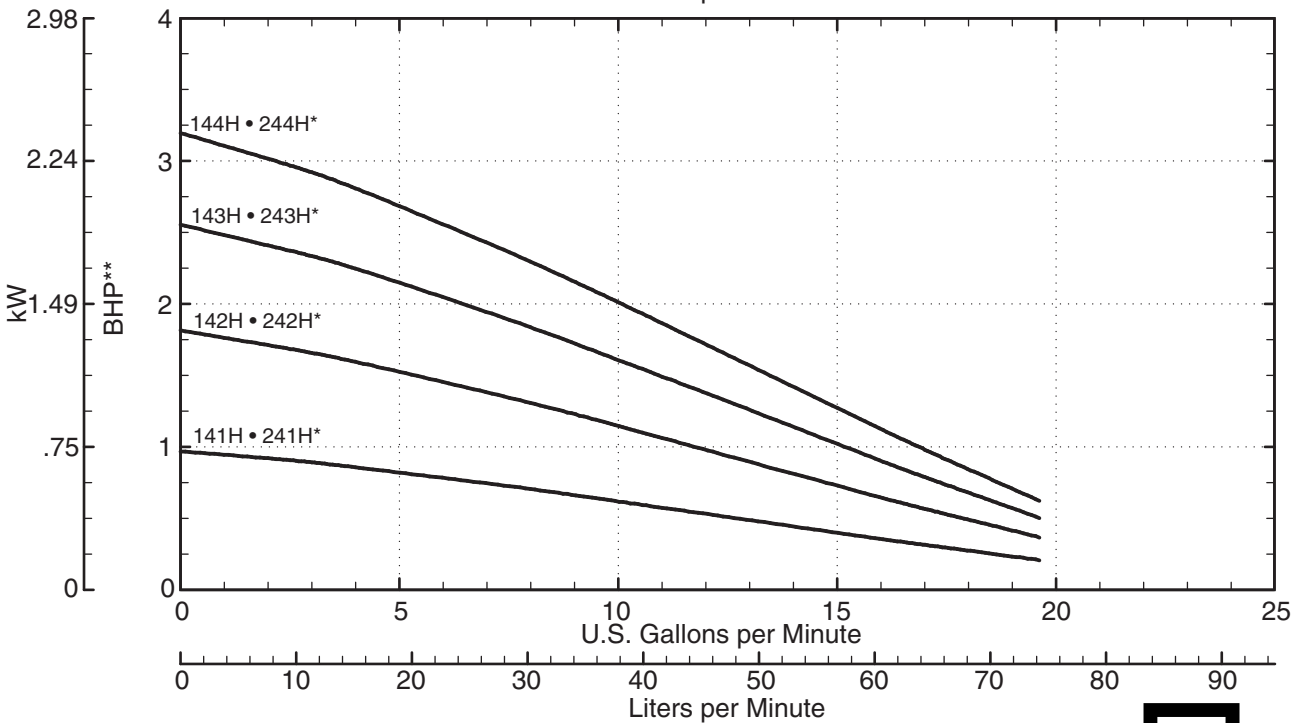
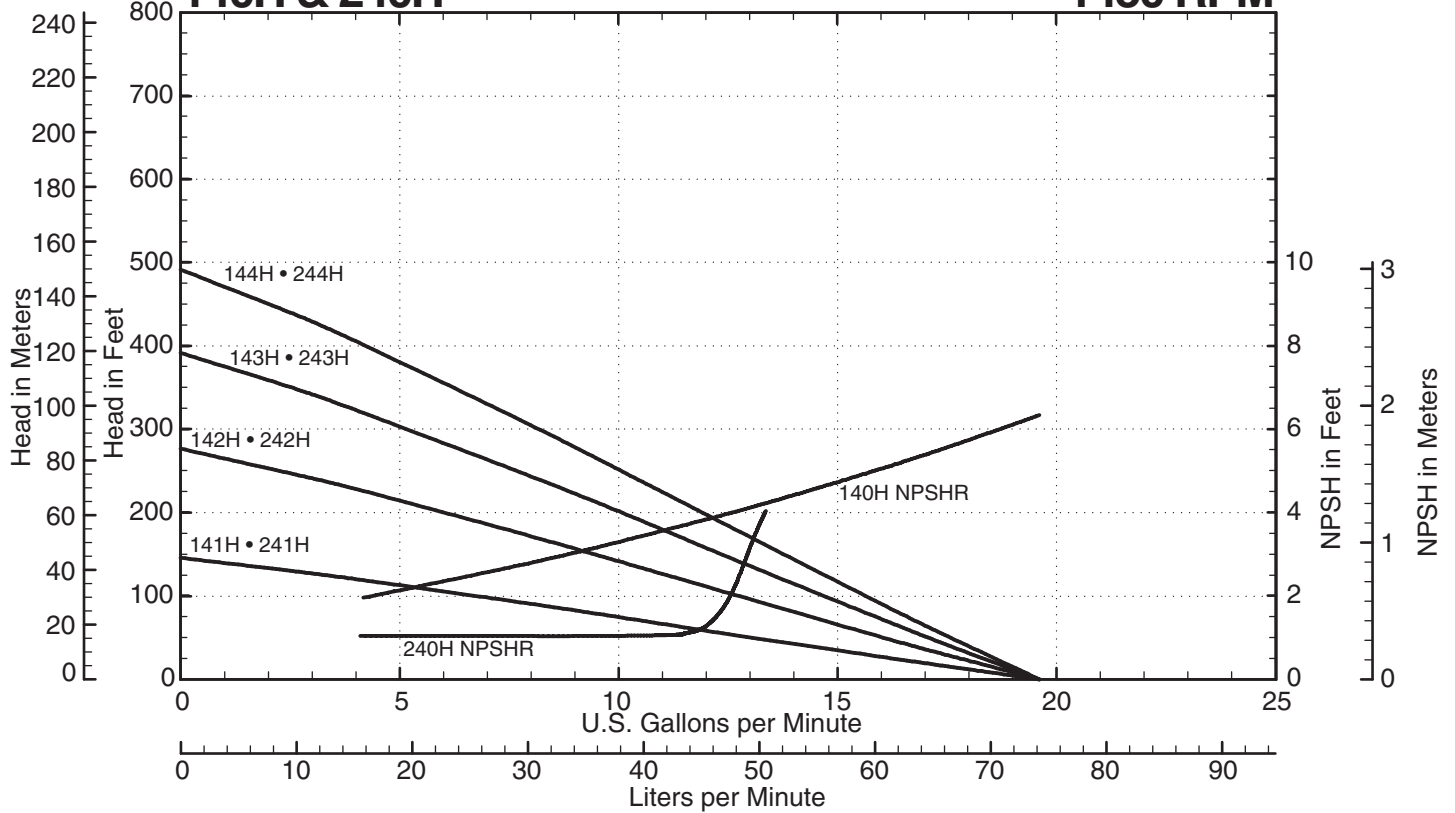

NOTES

Consult factory for operation below 3 GPM
 *Add 1/2 horsepower for 240 Series models
 **Horsepower data is valid for 1.0 specific gravity fluids only

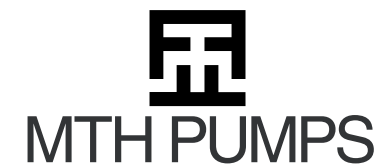

401 West Main Street • Plano, IL 60545-1436
 Phone: 630-552-4115 • Fax: 630-552-3688
 Email: SALES@MTHPUMPS.COM
 http://WWW.MTHPUMPS.COM



140 • 240 • 180 • 280 SERIES

Performance Curves

140I & 240I*

1750 RPM

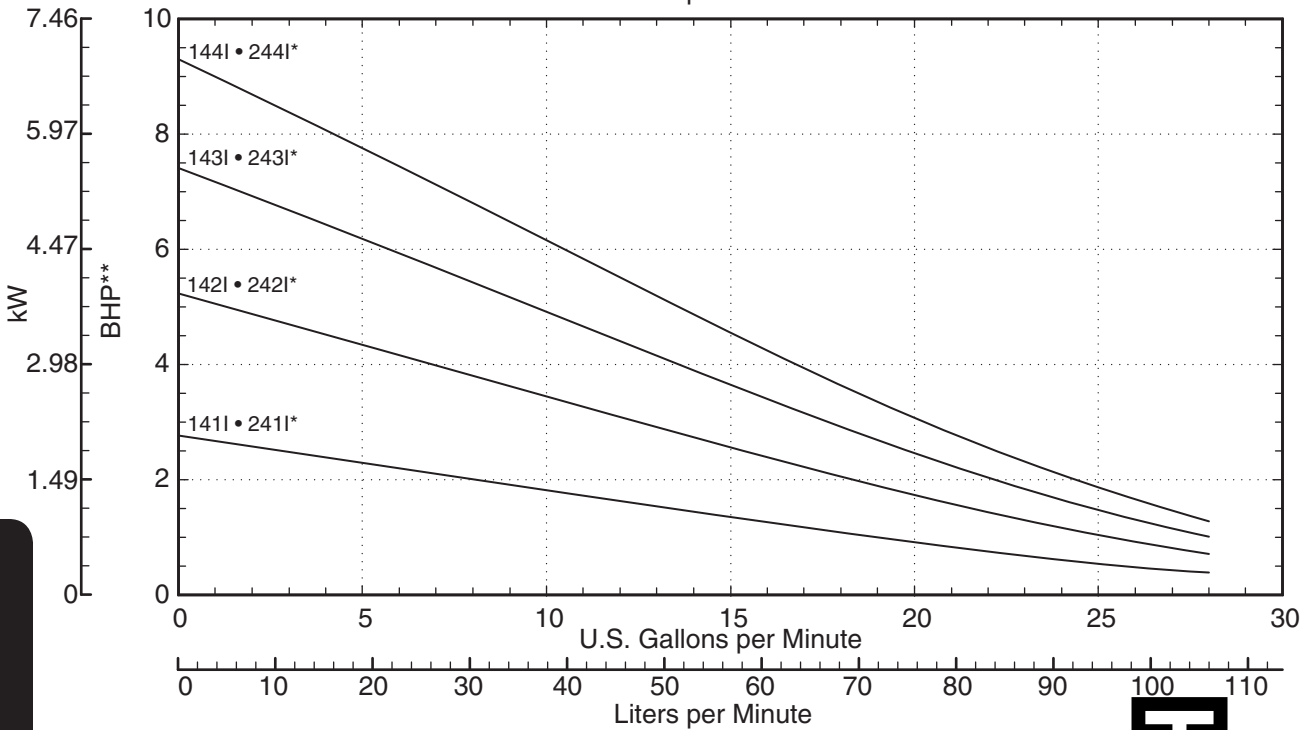
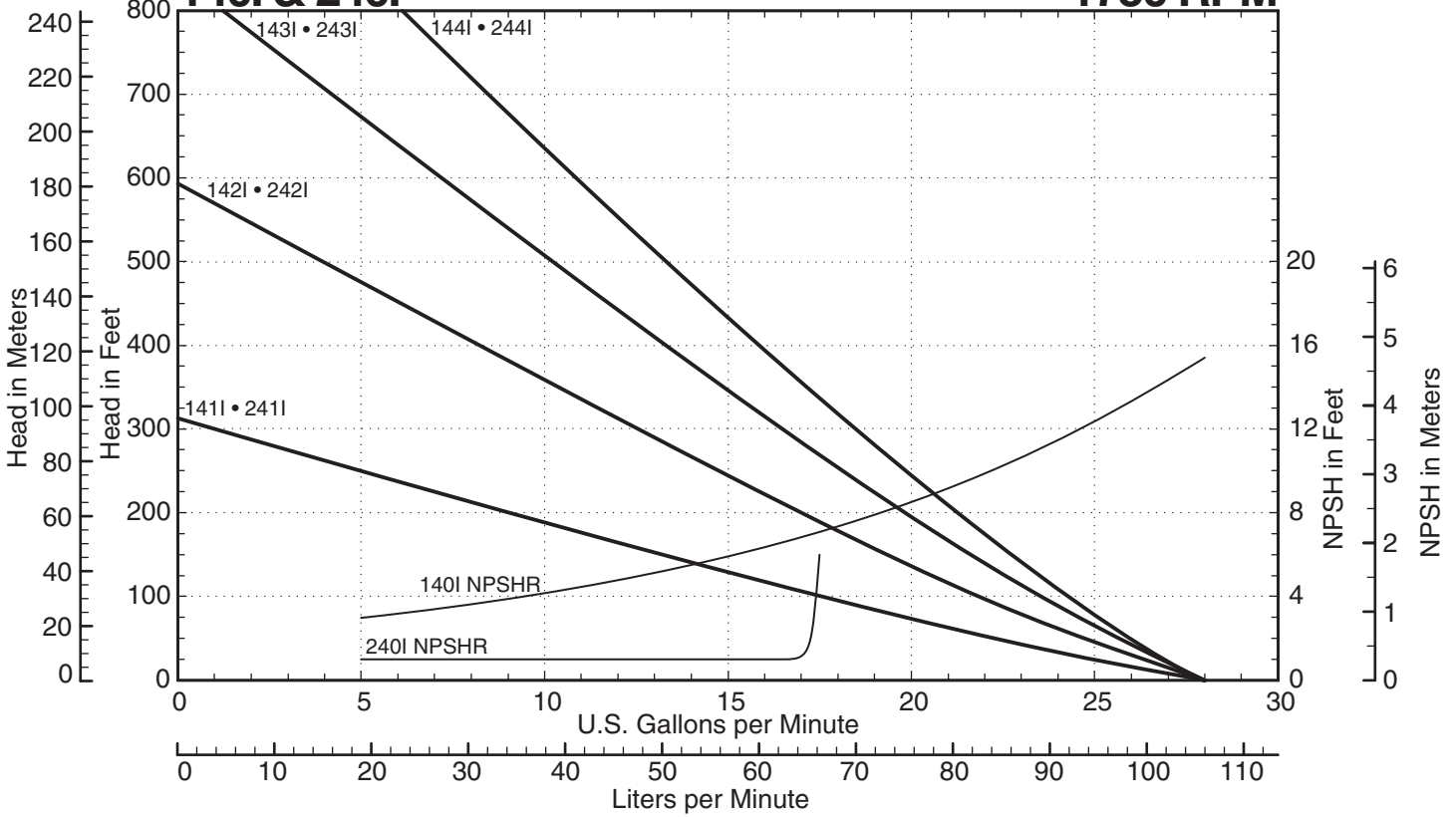

140 • 240 SERIES PUMPS

NOTES

- Consult factory for operation below 3 GPM
- *Add 1/2 horsepower for 240 Series models
- **Horsepower data is valid for 1.0 specific gravity fluids only



401 West Main Street • Plano, IL 60545-1436
 Phone: 630-552-4115 • Fax: 630-552-3688
 Email: SALES@MTHPUMPS.COM
 http://WWW.MTHPUMPS.COM



140 • 240 • 180 • 280 SERIES

Performance Curves 140I & 240I*

1450 RPM

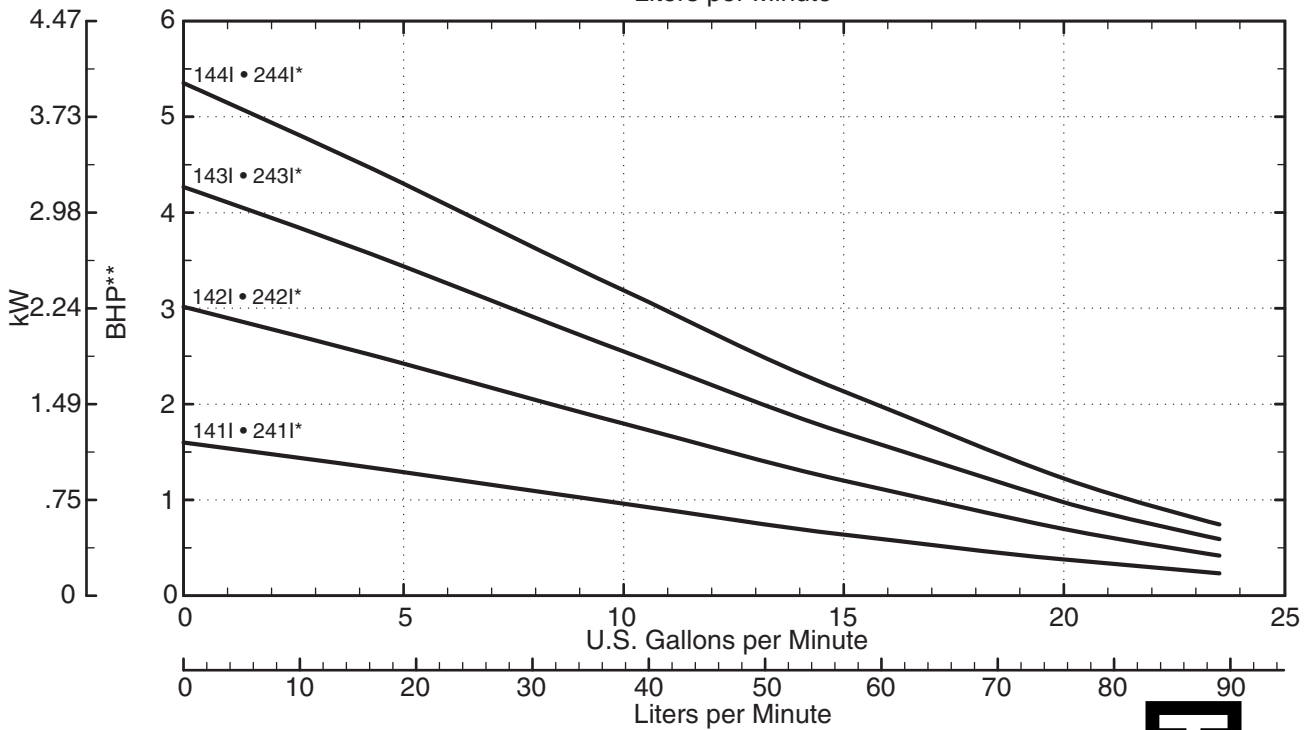
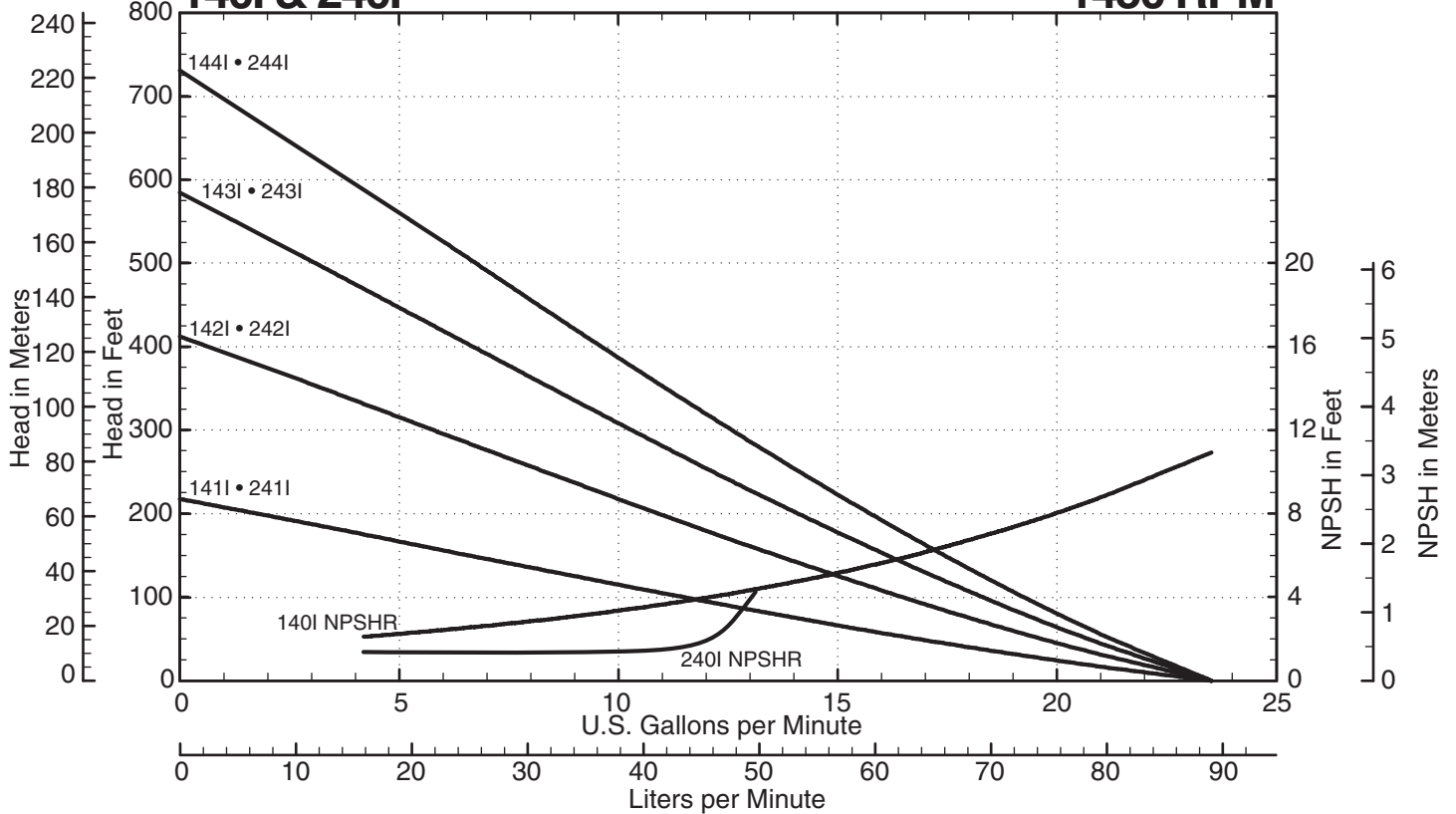

NOTES

Consult factory for operation below 3 GPM
 *Add 1/2 horsepower for 240 Series models
 **Horsepower data is valid for 1.0 specific gravity fluids only



401 West Main Street • Plano, IL 60545-1436
 Phone: 630-552-4115 • Fax: 630-552-3688
 Email: SALES@MTHPUMPS.COM
 http://WWW.MTHPUMPS.COM



140 • 240 • 180 • 280 SERIES

Performance Curves 140IA & 240IA*

1750 RPM

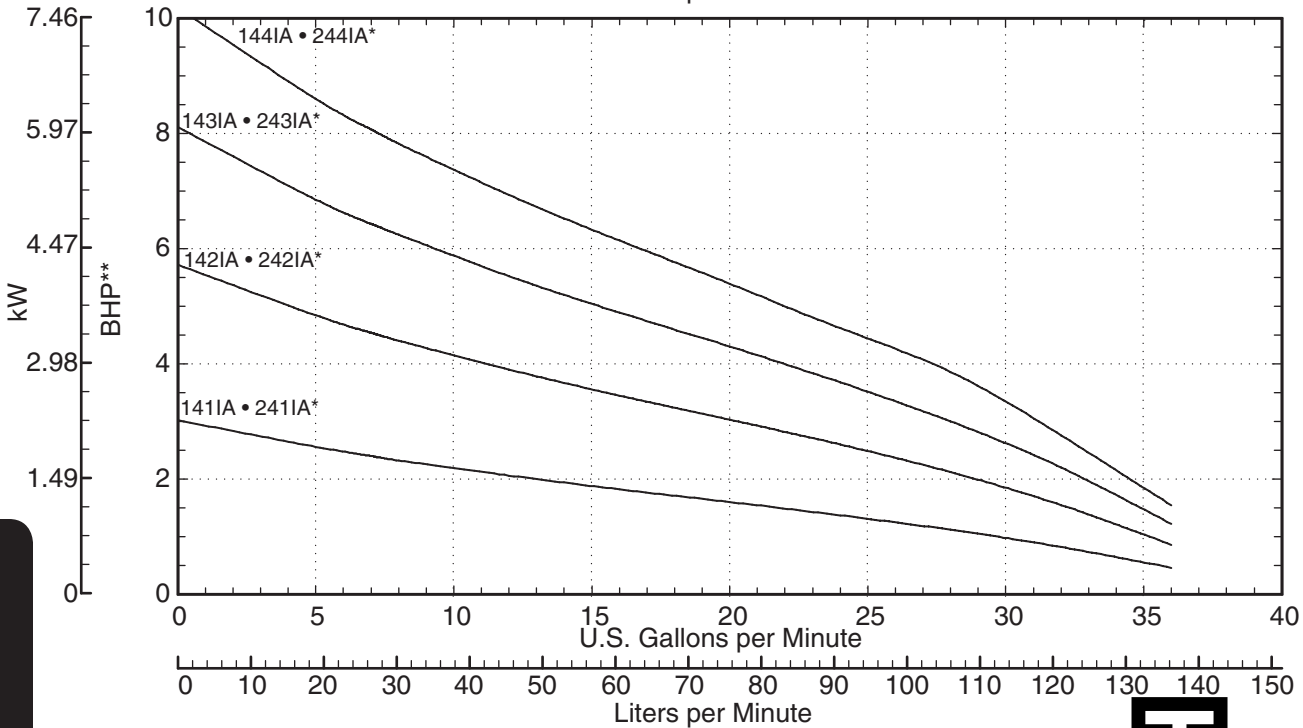
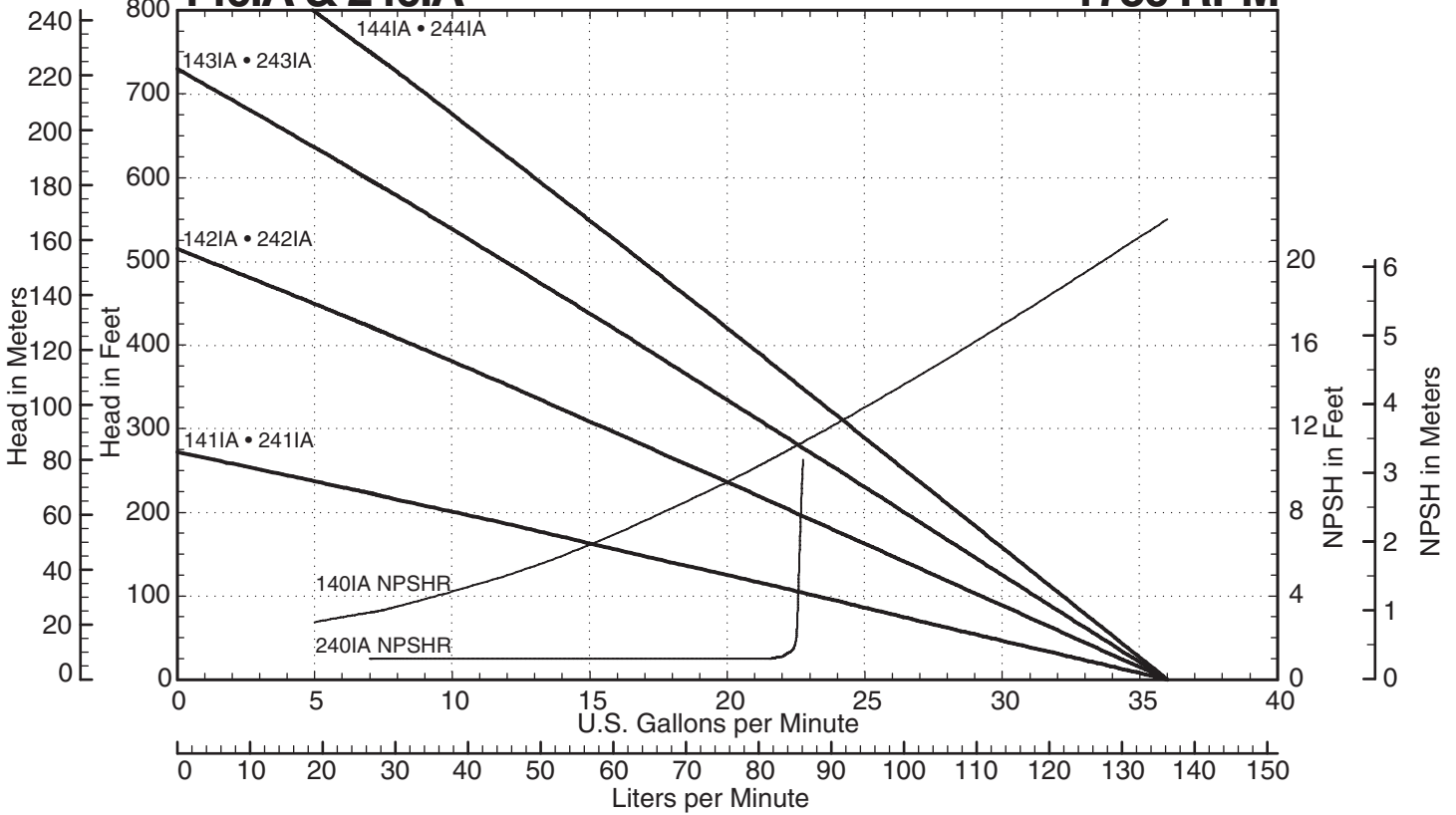

140 • 240 SERIES PUMPS

NOTES

- Consult factory for operation below 5 GPM
- *Add 1/2 horsepower for 240 Series models
- **Horsepower data is valid for 1.0 specific gravity fluids only



401 West Main Street • Plano, IL 60545-1436
 Phone: 630-552-4115 • Fax: 630-552-3688
 Email: SALES@MTHPUMPS.COM
 http://WWW.MTHPUMPS.COM



140 • 240 • 180 • 280 SERIES

Performance Curves 140IA & 240IA*

1450 RPM

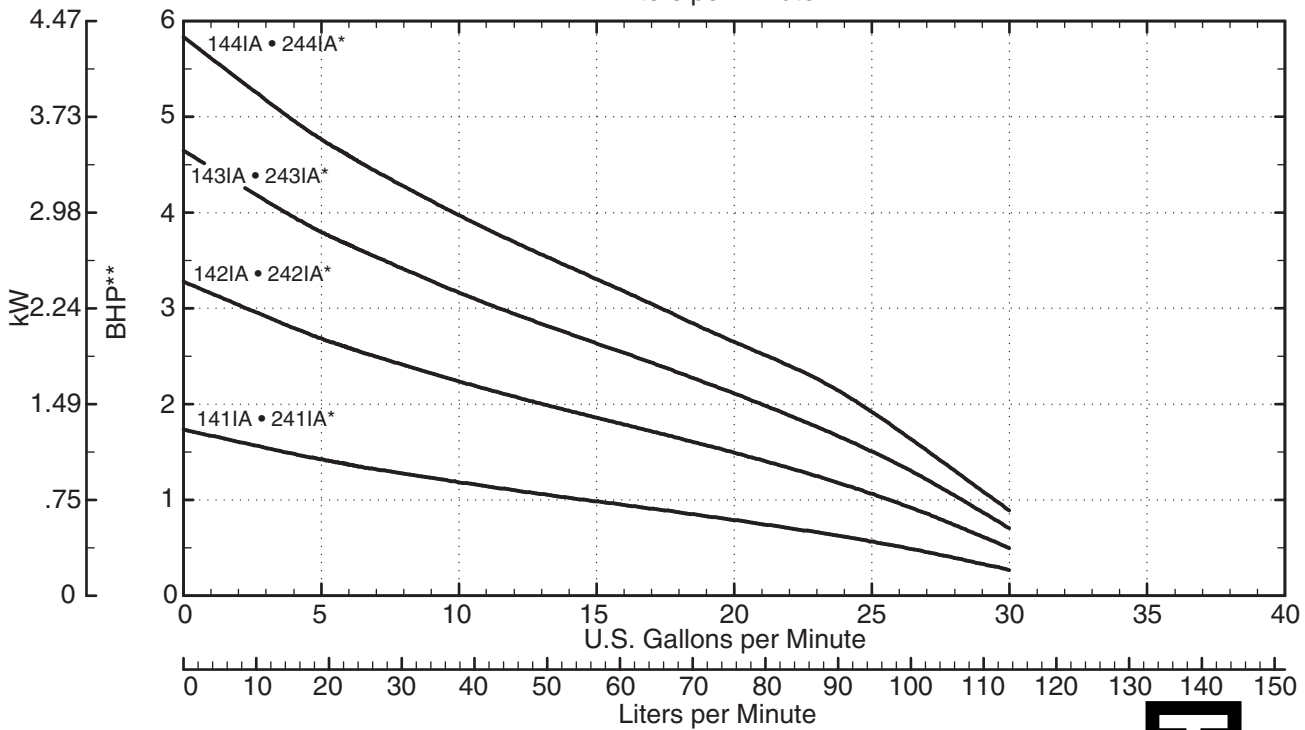
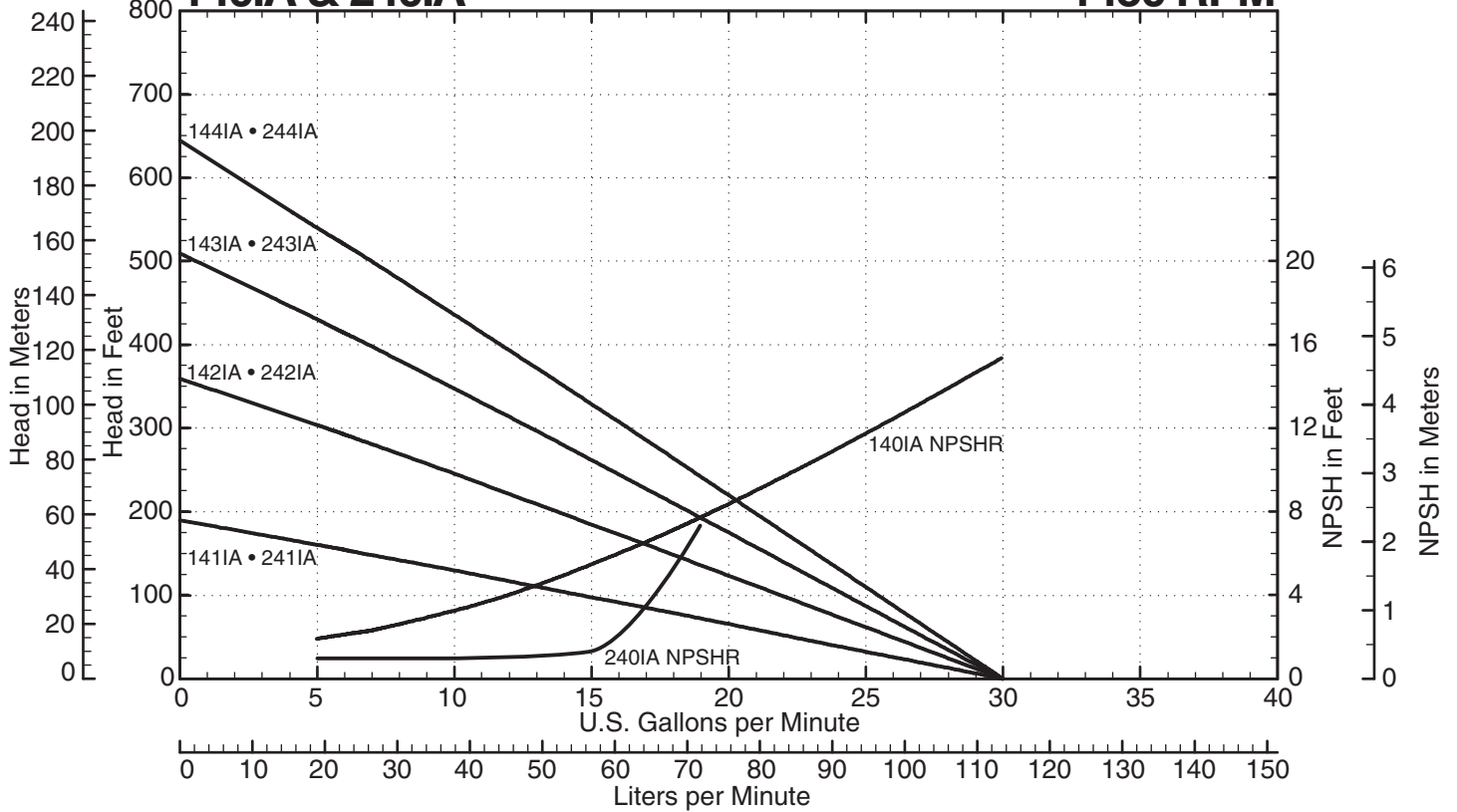

NOTES

Consult factory for operation below 5 GPM
 *Add 1/2 horsepower for 240 Series models
 **Horsepower data is valid for 1.0 specific gravity fluids only



401 West Main Street • Plano, IL 60545-1436
 Phone: 630-552-4115 • Fax: 630-552-3688
 Email: SALES@MTHPUMPS.COM
 http://WWW.MTHPUMPS.COM

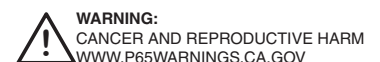

140 • 240 • 180 • 280 SERIES

Performance Curves

180K & 280K*

1750 RPM

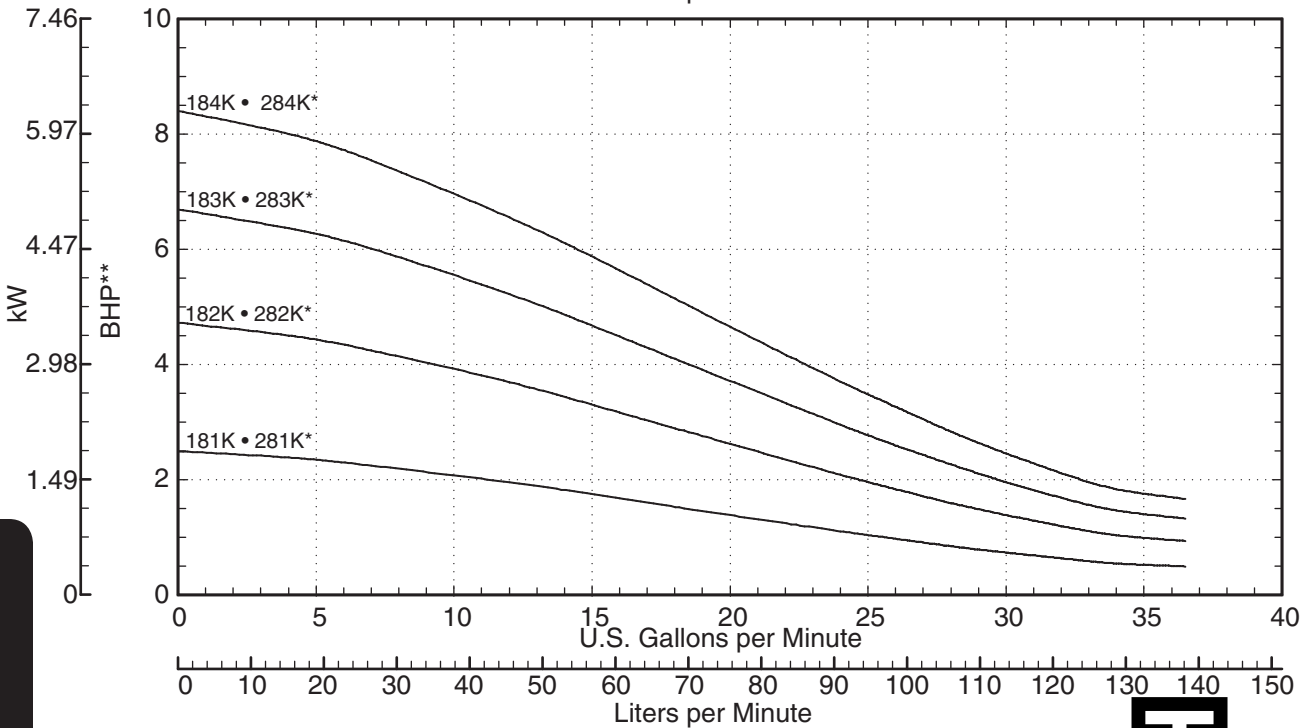
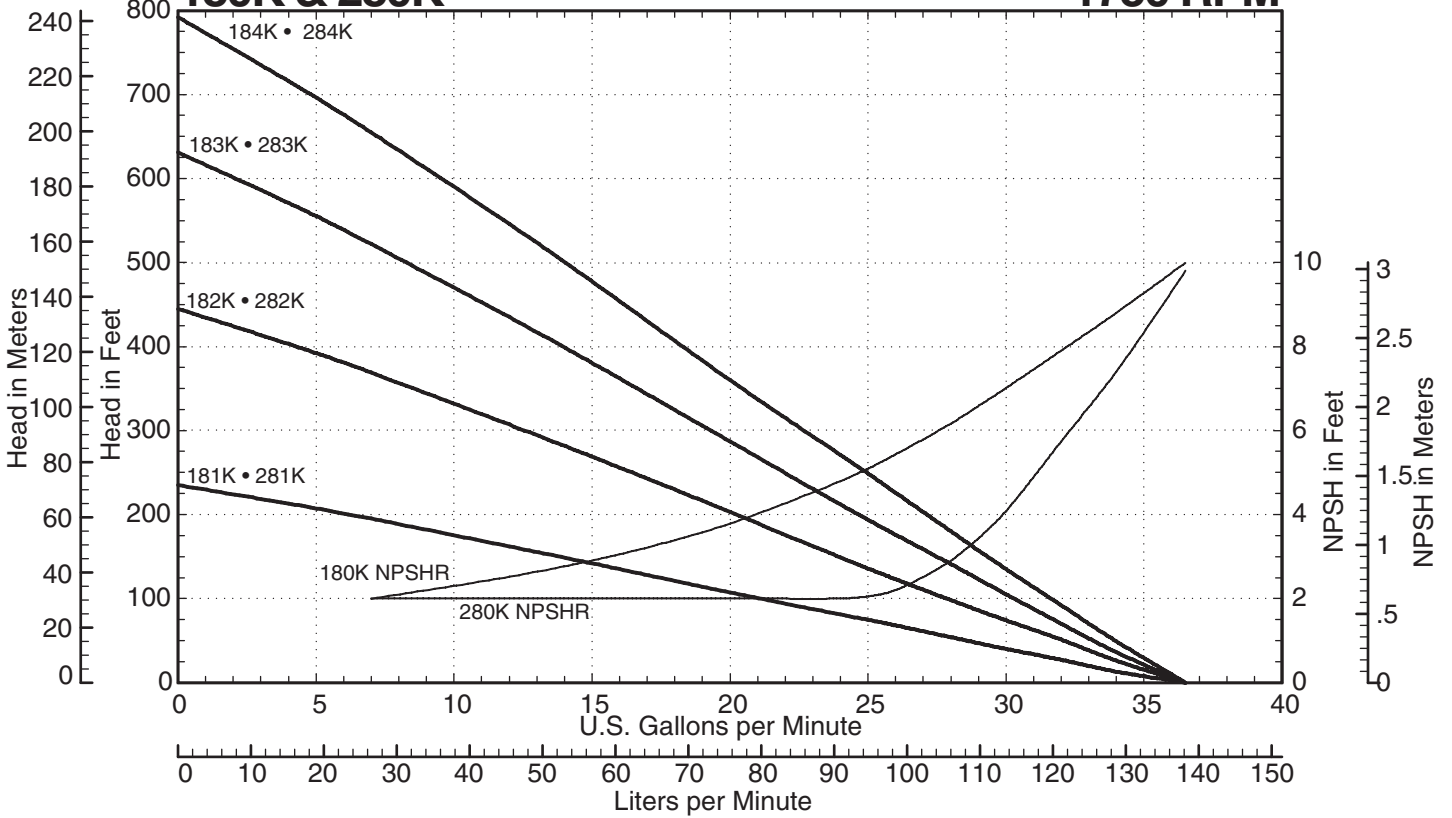

140 • 240 SERIES PUMPS

NOTES

- Consult factory for operation below 5 GPM
- *Add 1/2 horsepower for 280 Series models
- **Horsepower data is valid for 1.0 specific gravity fluids only



401 West Main Street • Plano, IL 60545-1436
 Phone: 630-552-4115 • Fax: 630-552-3688
 Email: SALES@MTHPUMPS.COM
 http://WWW.MTHPUMPS.COM



140 • 240 • 180 • 280 SERIES

Performance Curves 180K & 280K*

1450 RPM

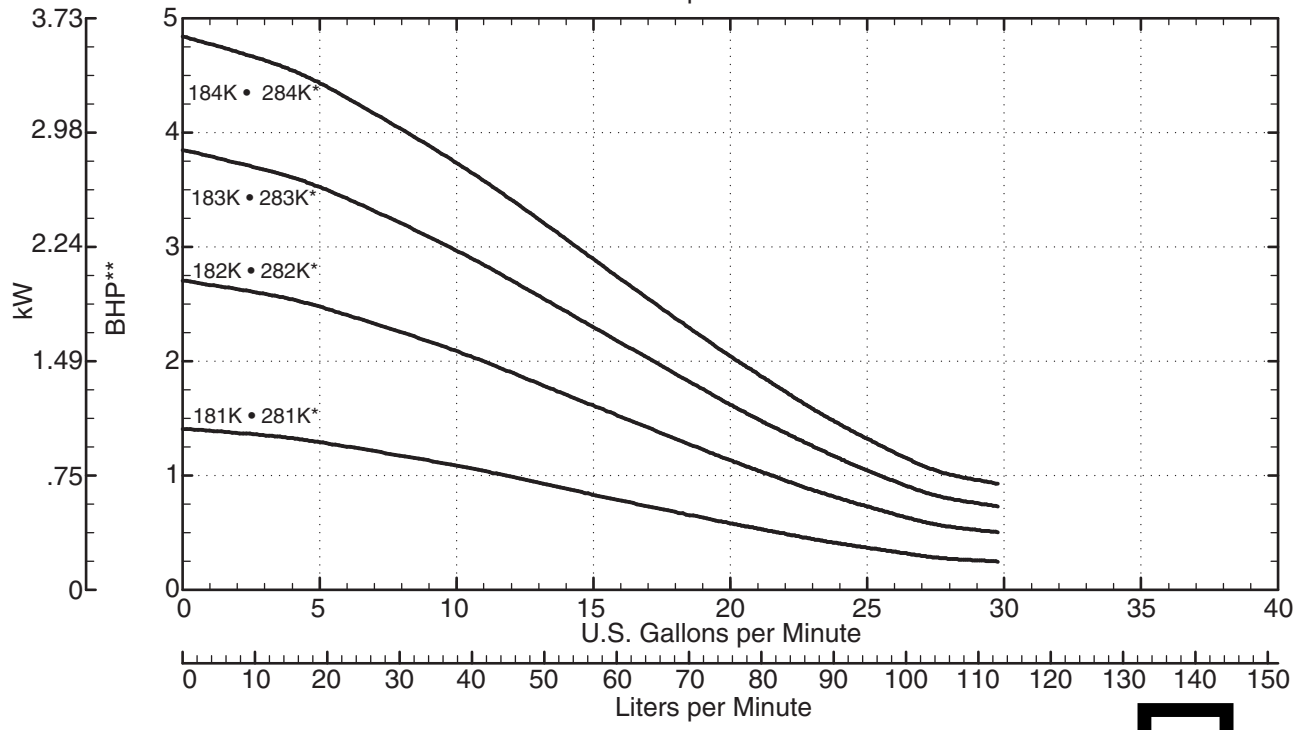
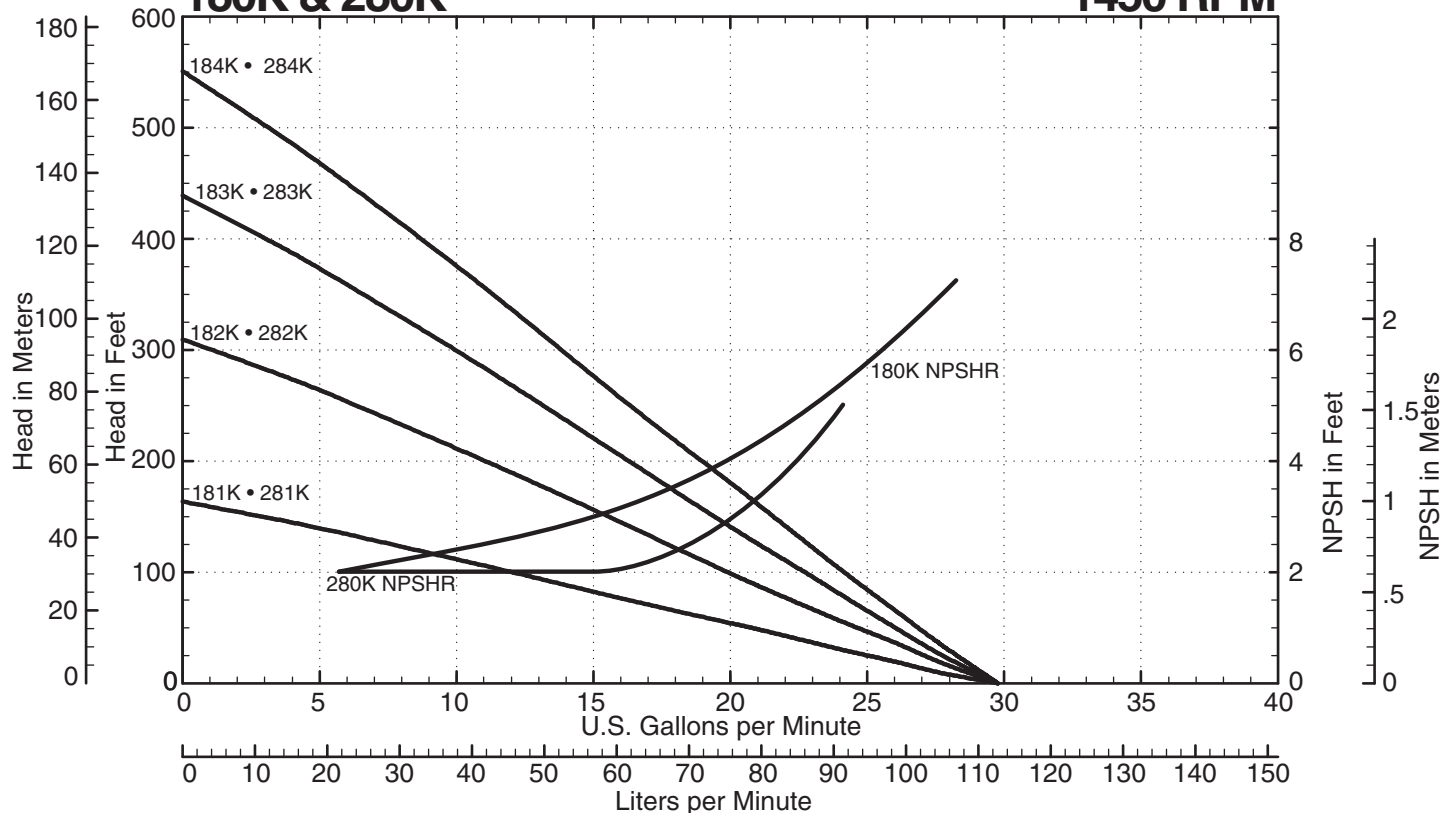

NOTES
 Consult factory for operation below 5 GPM
 *Add 1/2 horsepower for 280 Series models
 **Horsepower data is valid for 1.0 specific gravity fluids only

MTH PUMPS
 401 West Main Street • Plano, IL 60545-1436
 Phone: 630-552-4115 • Fax: 630-552-3688
 Email: SALES@MTHPUMPS.COM
 http://WWW.MTHPUMPS.COM

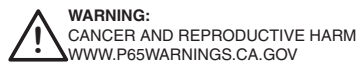

140 • 240 SERIES PUMPS

140 • 240 • 180 • 280 SERIES

Performance Curves 180M & 280M*

1750 RPM

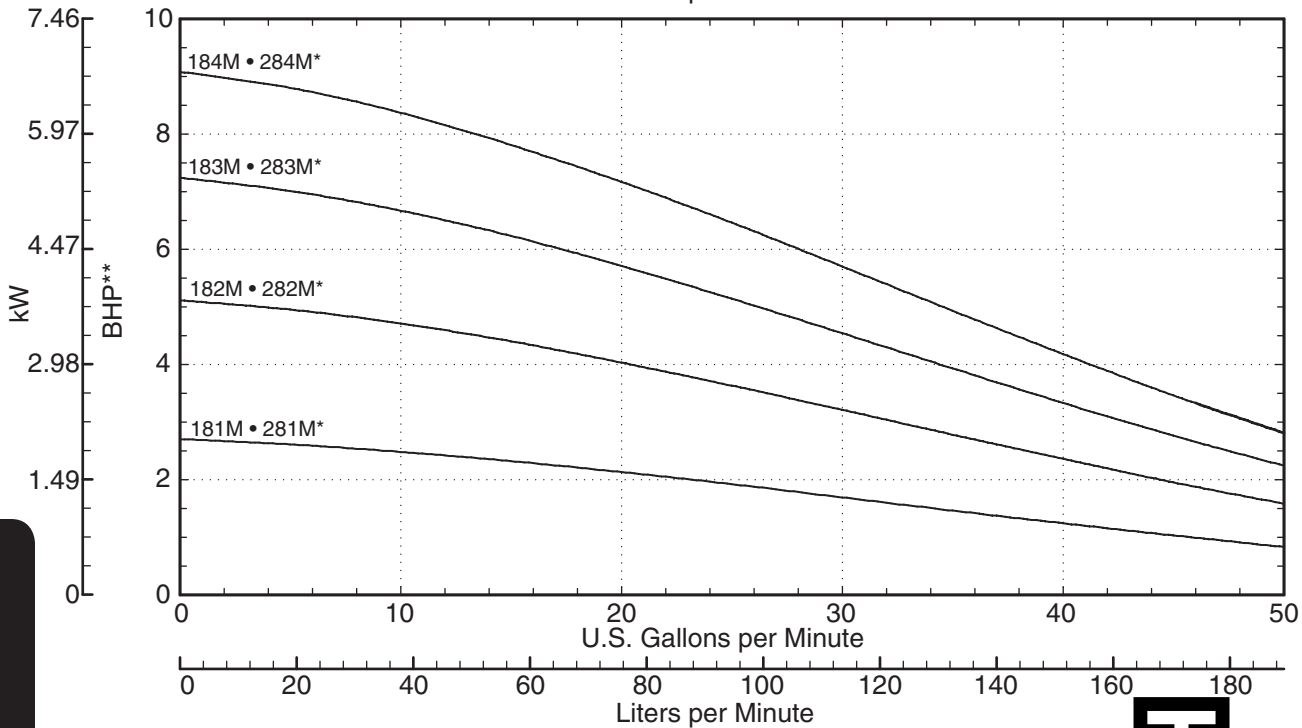
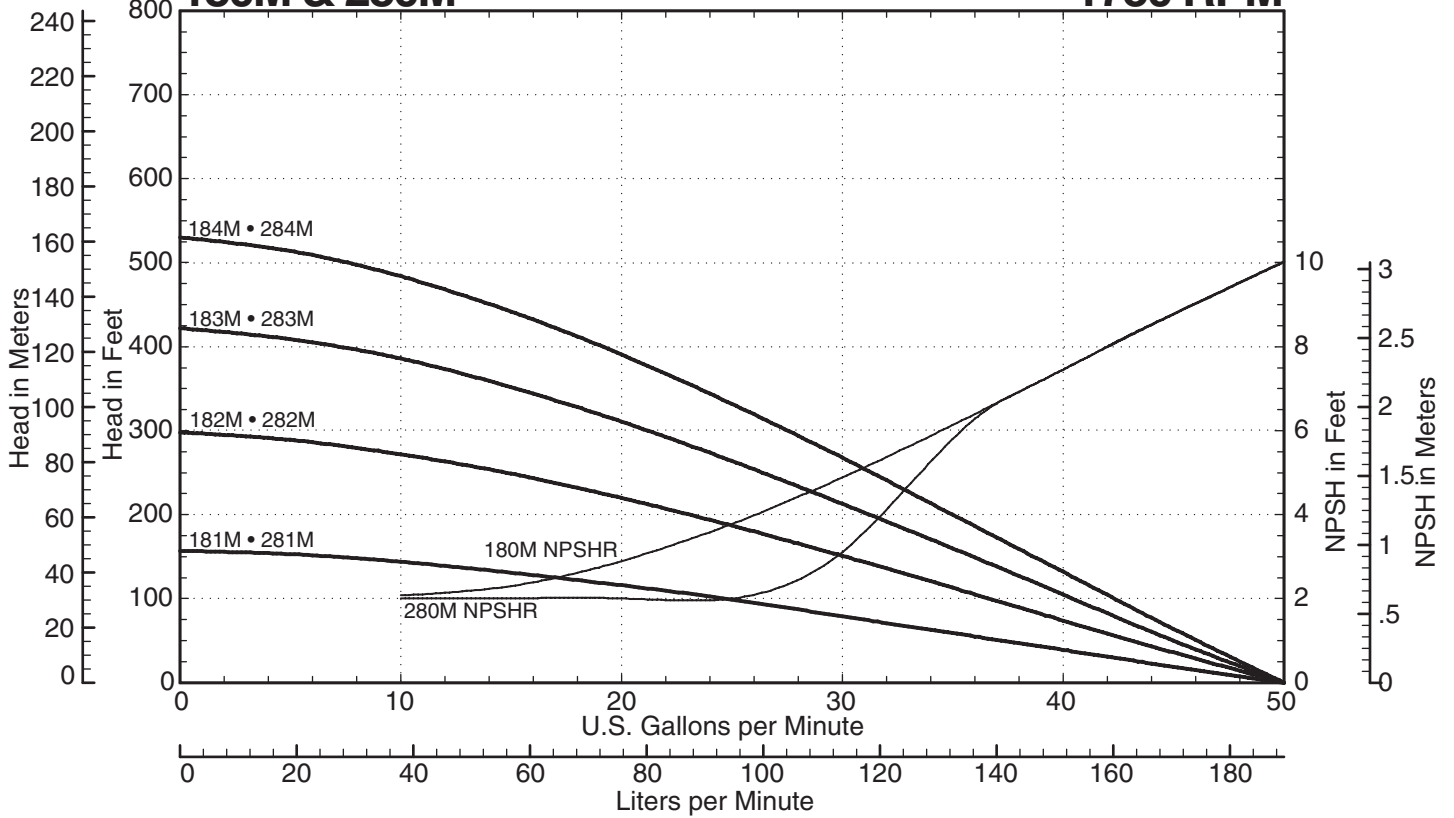

140 • 240 SERIES PUMPS

NOTES

- Consult factory for operation below 5 GPM
- *Add 1/2 horsepower for 280 Series models
- **Horsepower data is valid for 1.0 specific gravity fluids only



401 West Main Street • Plano, IL 60545-1436
 Phone: 630-552-4115 • Fax: 630-552-3688
 Email: SALES@MTHPUMPS.COM
 http://WWW.MTHPUMPS.COM



140 • 240 • 180 • 280 SERIES

Performance Curves

180M & 280M*

1450 RPM

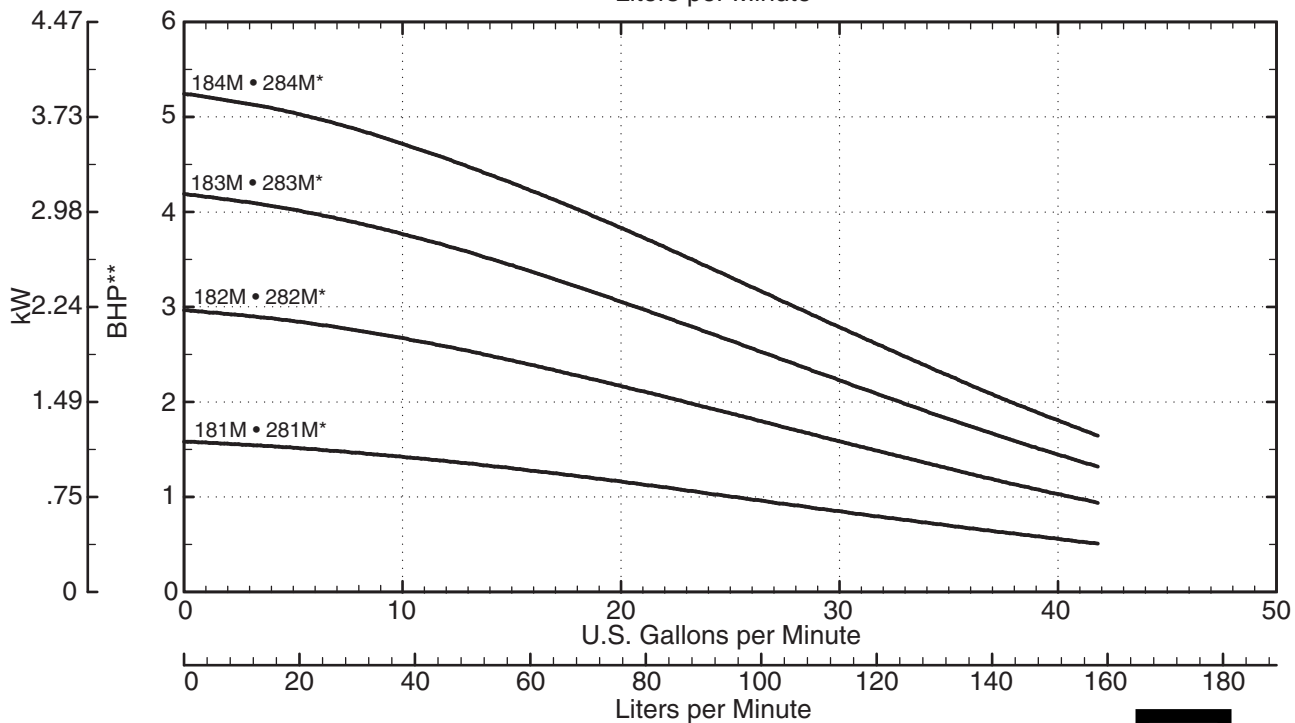
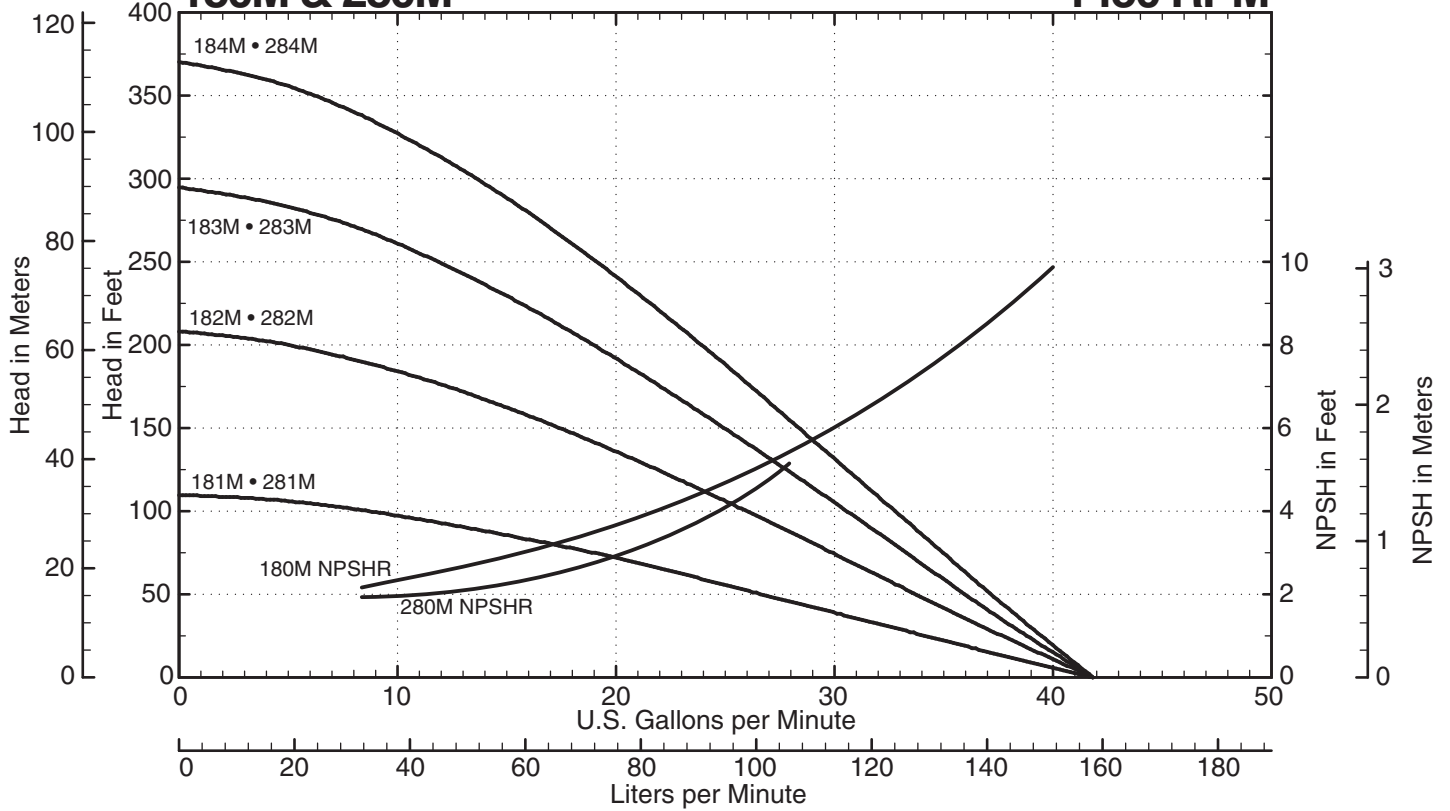

NOTES

Consult factory for operation below 5 GPM
 *Add 1/2 horsepower for 280 Series models
 **Horsepower data is valid for 1.0 specific gravity fluids only

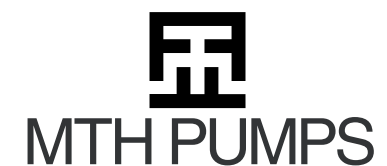

401 West Main Street • Plano, IL 60545-1436
 Phone: 630-552-4115 • Fax: 630-552-3688
 Email: SALES@MTHPUMPS.COM
 http://WWW.MTHPUMPS.COM



140 • 240 SERIES PUMPS

140 • 240 • 180 • 280 SERIES

Performance Curves 180P & 280P*

1750 RPM

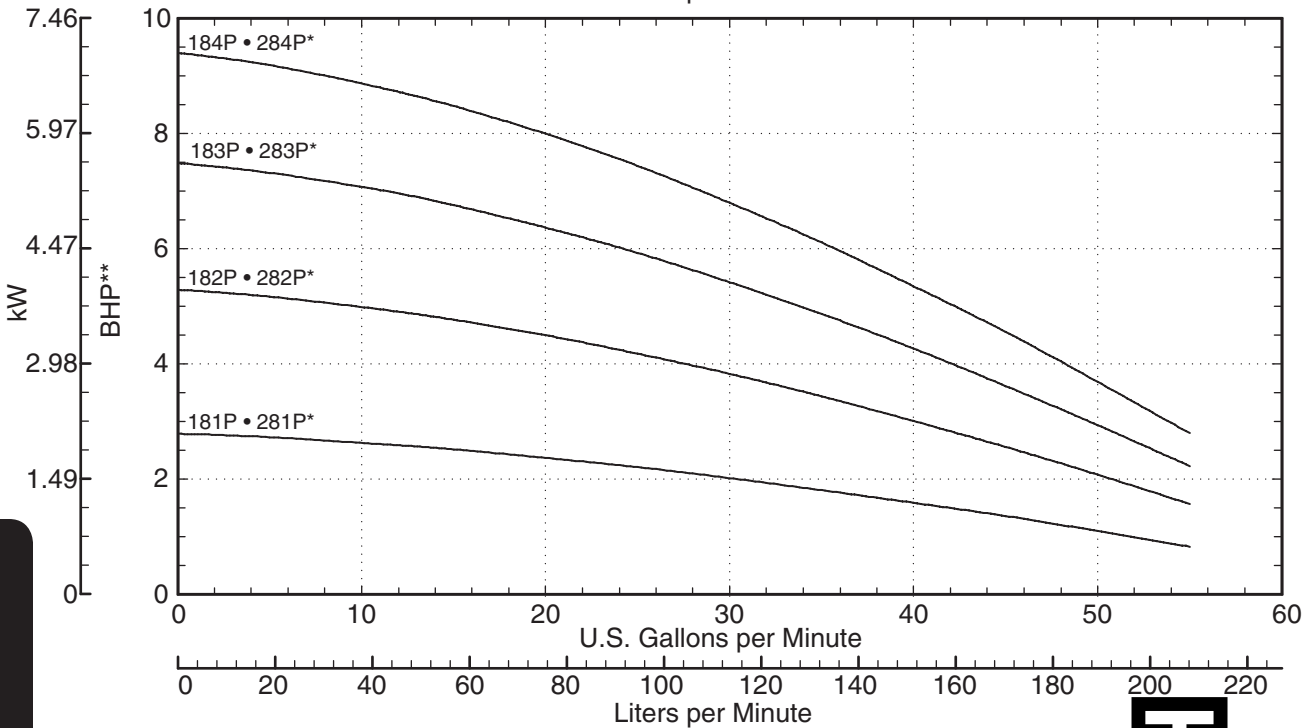
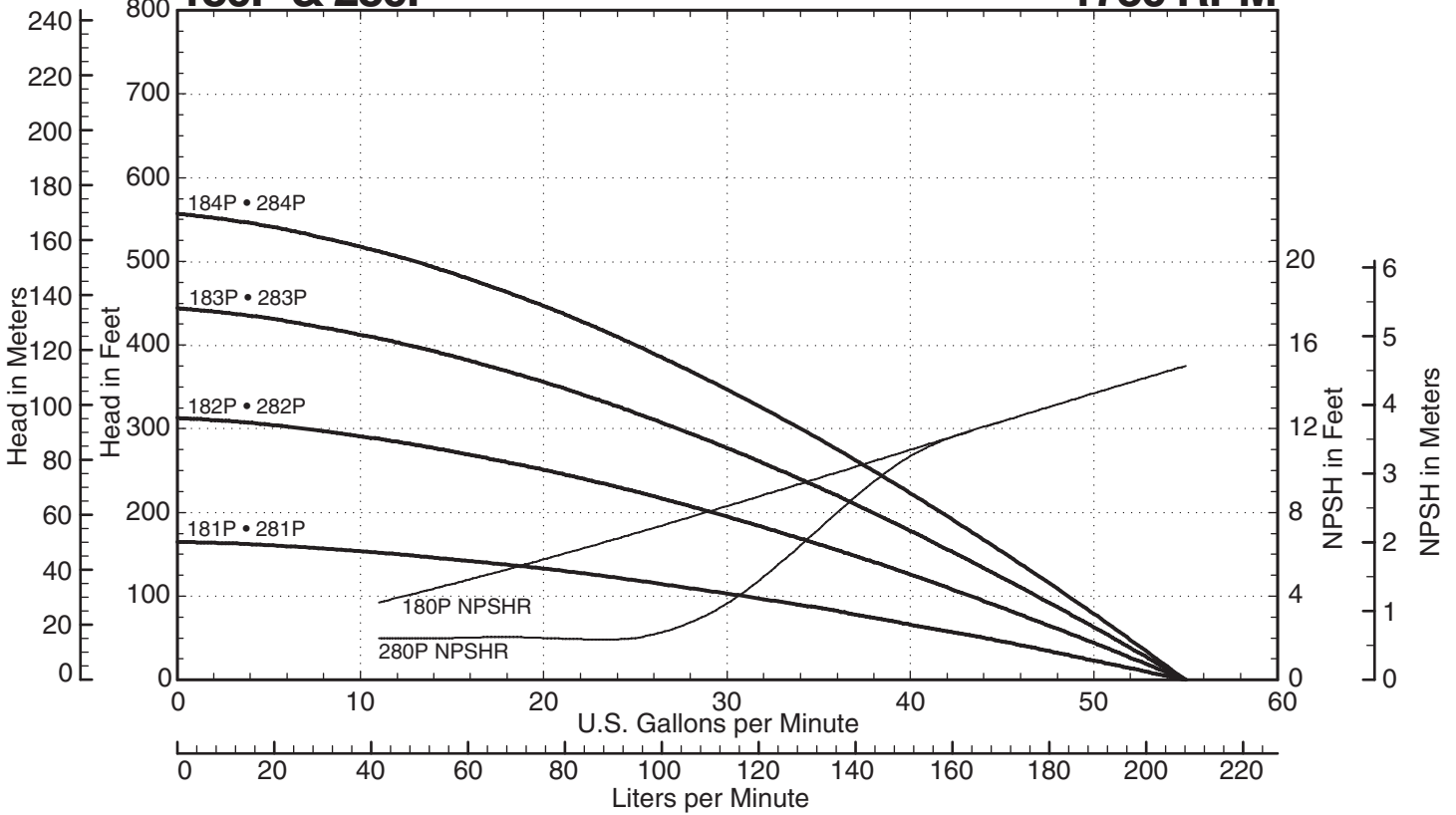

140 • 240 SERIES PUMPS

NOTES

- Consult factory for operation below 8 GPM
- *Add 1/2 horsepower for 280 Series models
- **Horsepower data is valid for 1.0 specific gravity fluids only



401 West Main Street • Plano, IL 60545-1436
 Phone: 630-552-4115 • Fax: 630-552-3688
 Email: SALES@MTHPUMPS.COM
 http://WWW.MTHPUMPS.COM



140 • 240 • 180 • 280 SERIES

Performance Curves

180P & 280P*

1450 RPM

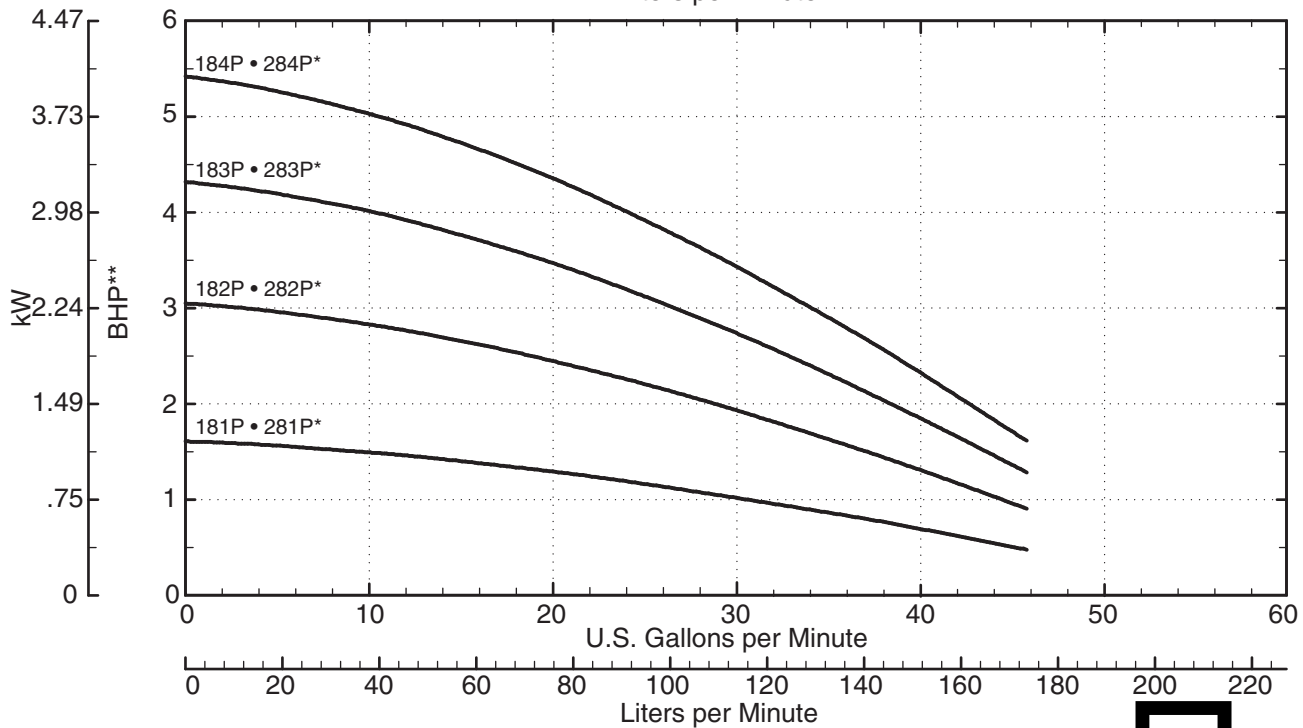
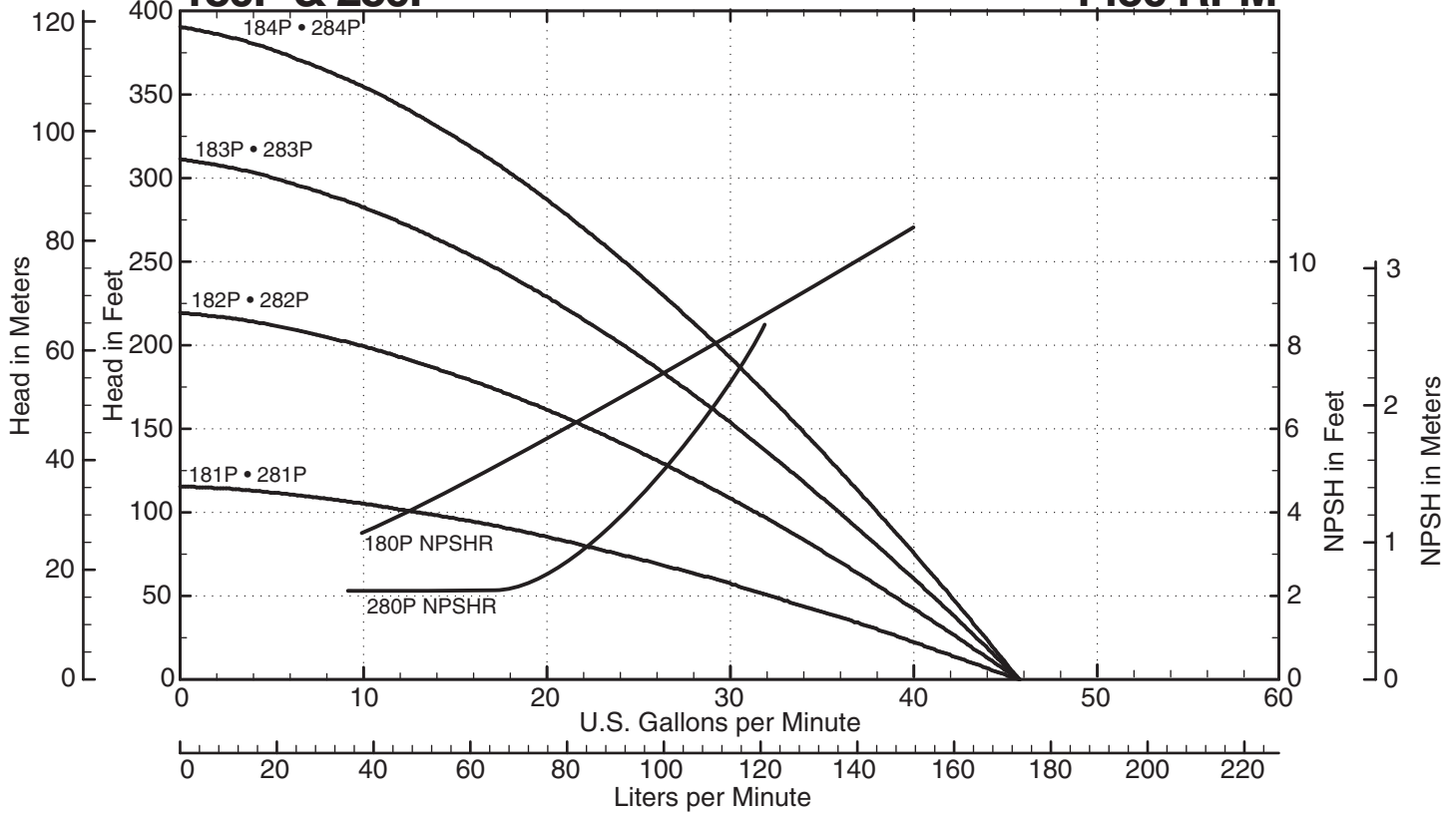

NOTES

Consult factory for operation below 8 GPM
 *Add 1/2 horsepower for 280 Series models
 **Horsepower data is valid for 1.0 specific gravity fluids only



401 West Main Street • Plano, IL 60545-1436
 Phone: 630-552-4115 • Fax: 630-552-3688
 Email: SALES@MTHPUMPS.COM
 http://WWW.MTHPUMPS.COM



140 • 240 • 180 • 280 SERIES

Performance Curves 180R & 280R*

1750 RPM

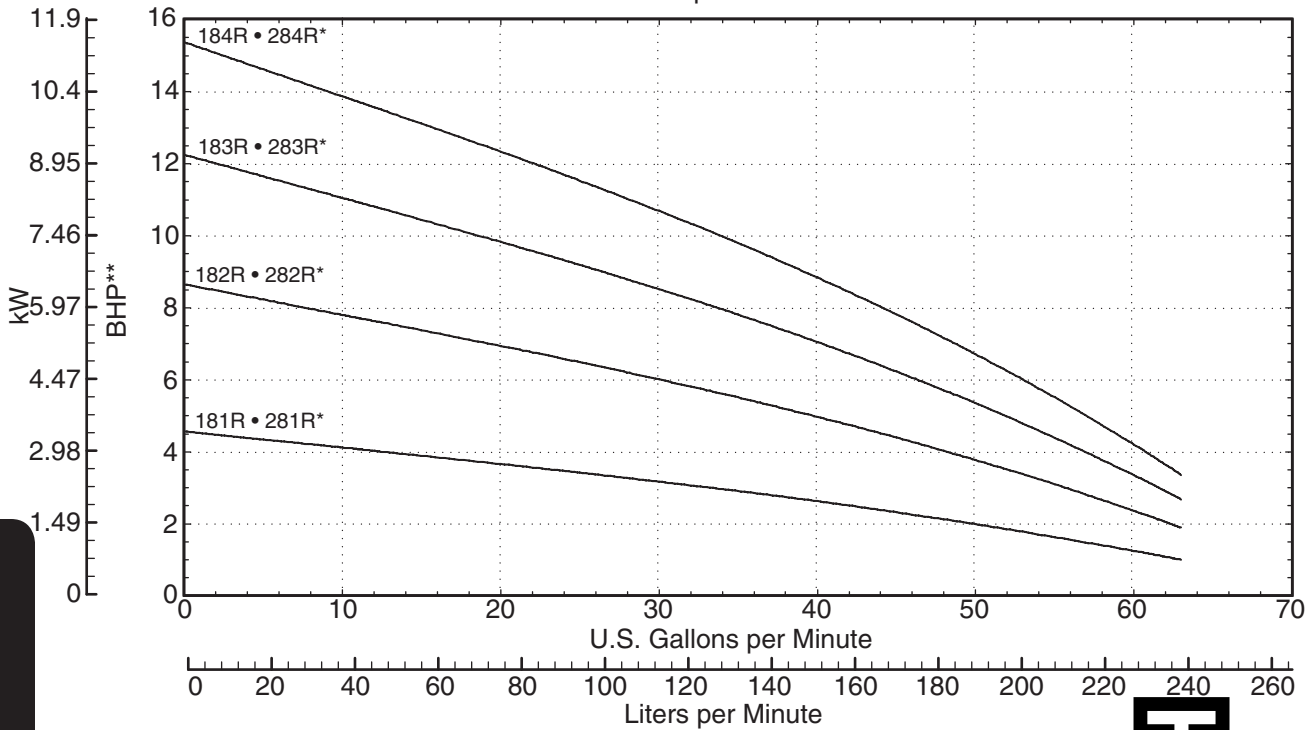
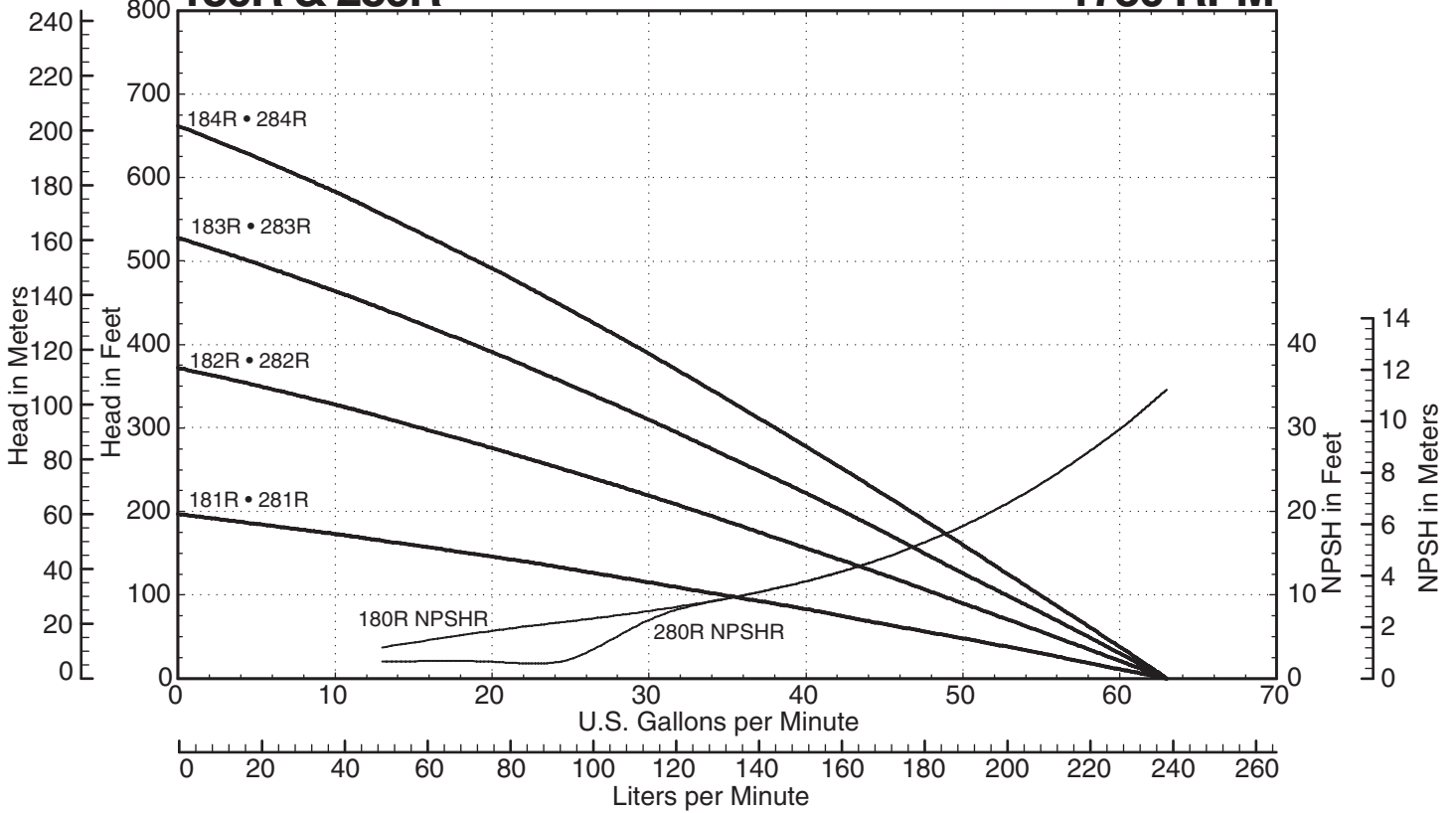

140 • 240 SERIES PUMPS

NOTES

- Consult factory for operation below 8 GPM
- *Add 1/2 horsepower for 280 Series models
- **Horsepower data is valid for 1.0 specific gravity fluids only

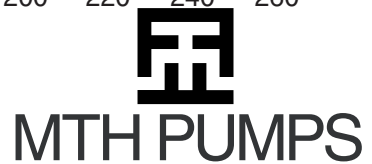

401 West Main Street • Plano, IL 60545-1436
 Phone: 630-552-4115 • Fax: 630-552-3688
 Email: SALES@MTHPUMPS.COM
 http://WWW.MTHPUMPS.COM



140 • 240 • 180 • 280 SERIES

Performance Curves 180R & 280R*

1450 RPM

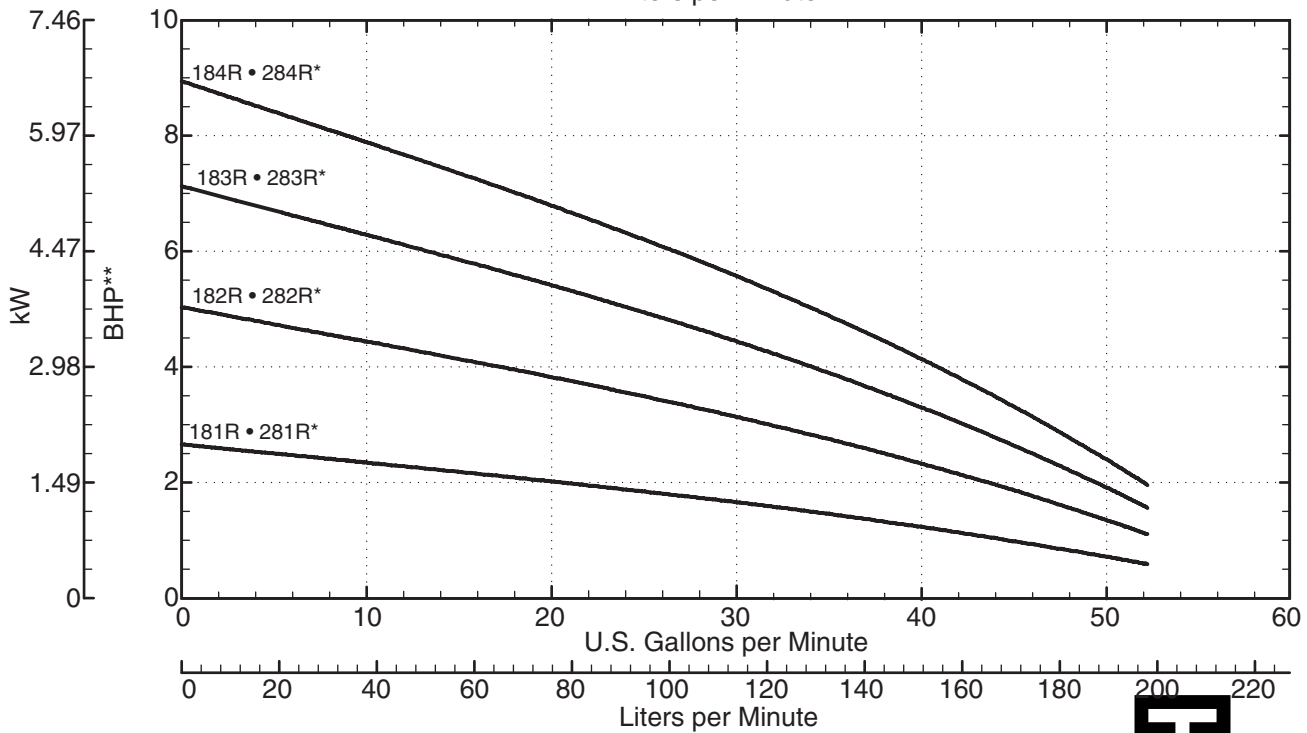
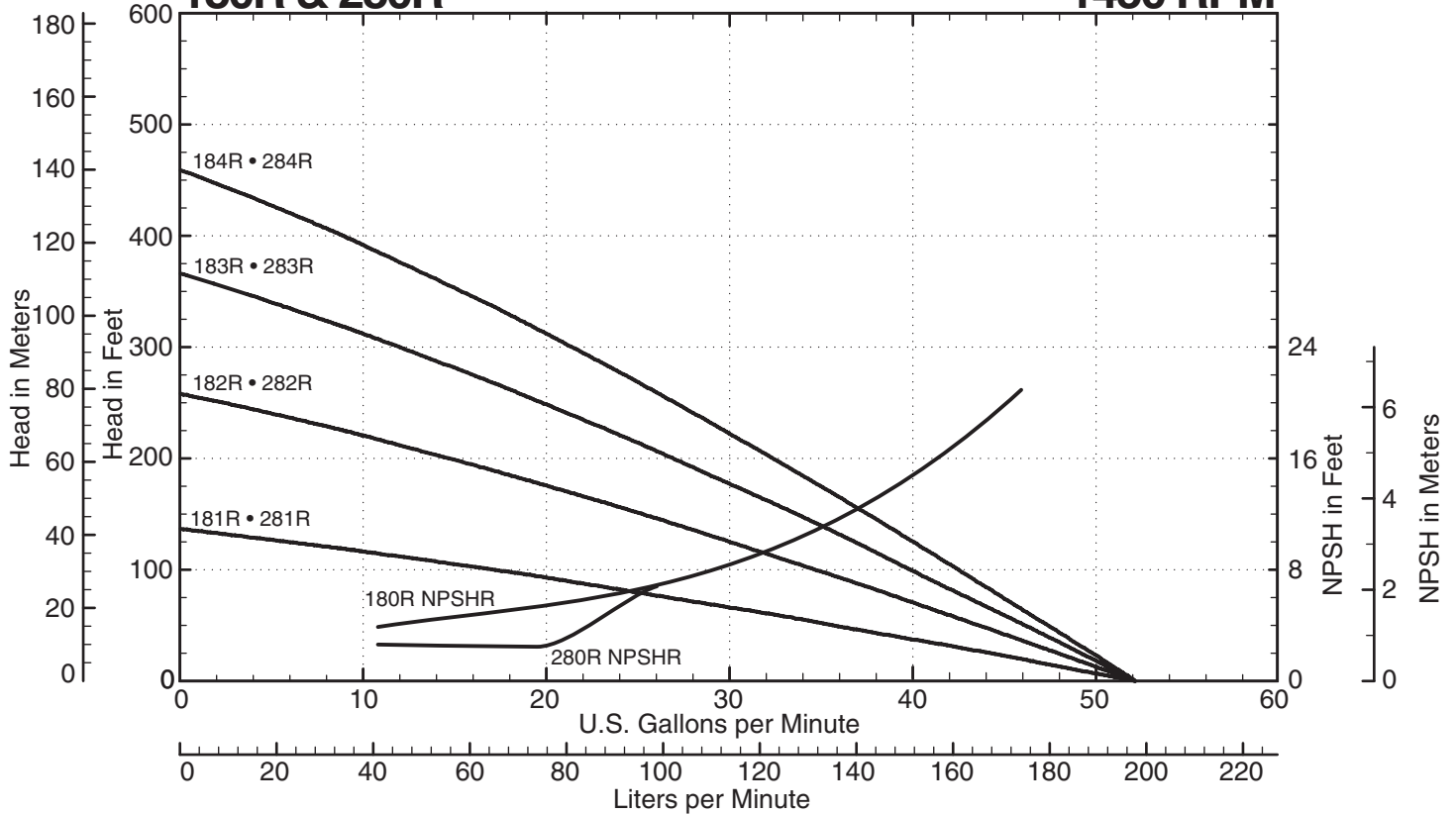

NOTES

Consult factory for operation below 8 GPM
 *Add 1/2 horsepower for 280 Series models
 **Horsepower data is valid for 1.0 specific gravity fluids only



401 West Main Street • Plano, IL 60545-1436
 Phone: 630-552-4115 • Fax: 630-552-3688
 Email: SALES@MTHPUMPS.COM
 http://WWW.MTHPUMPS.COM

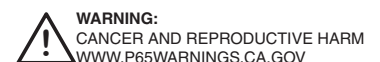

140 • 240 • 180 • 280 SERIES

Performance Curves

180S & 280S*

1750 RPM

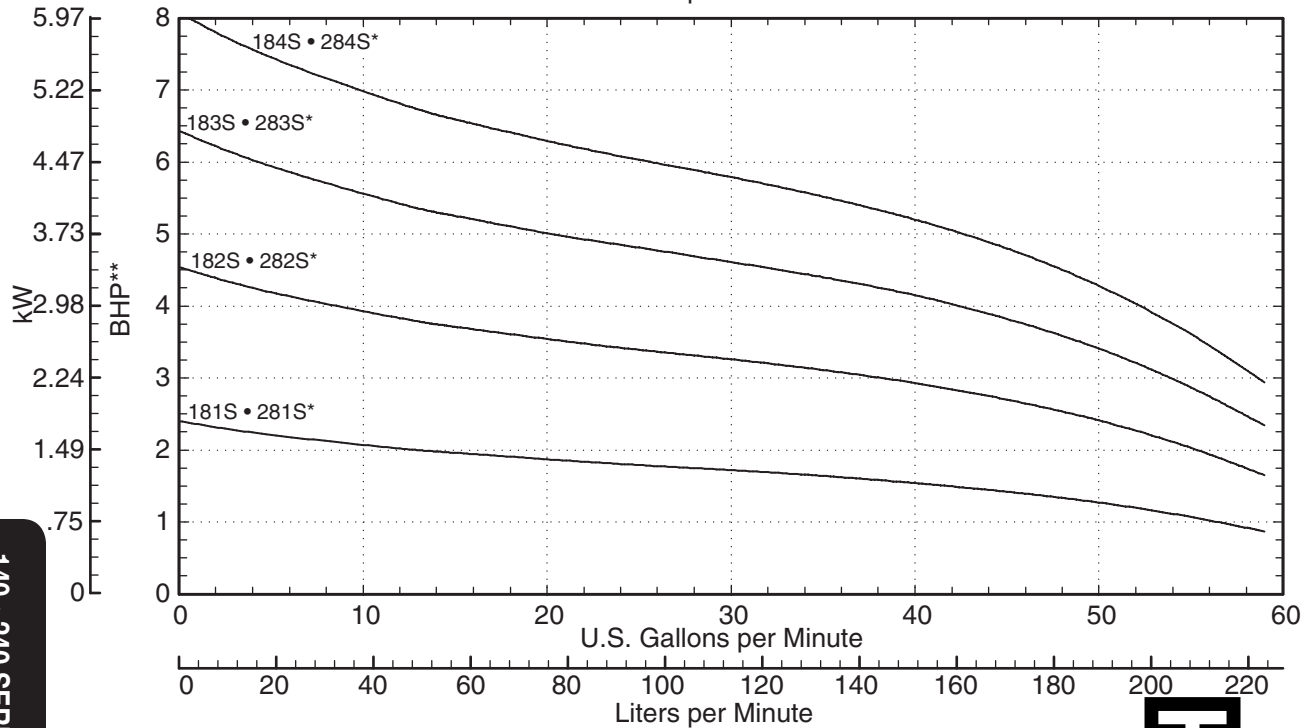
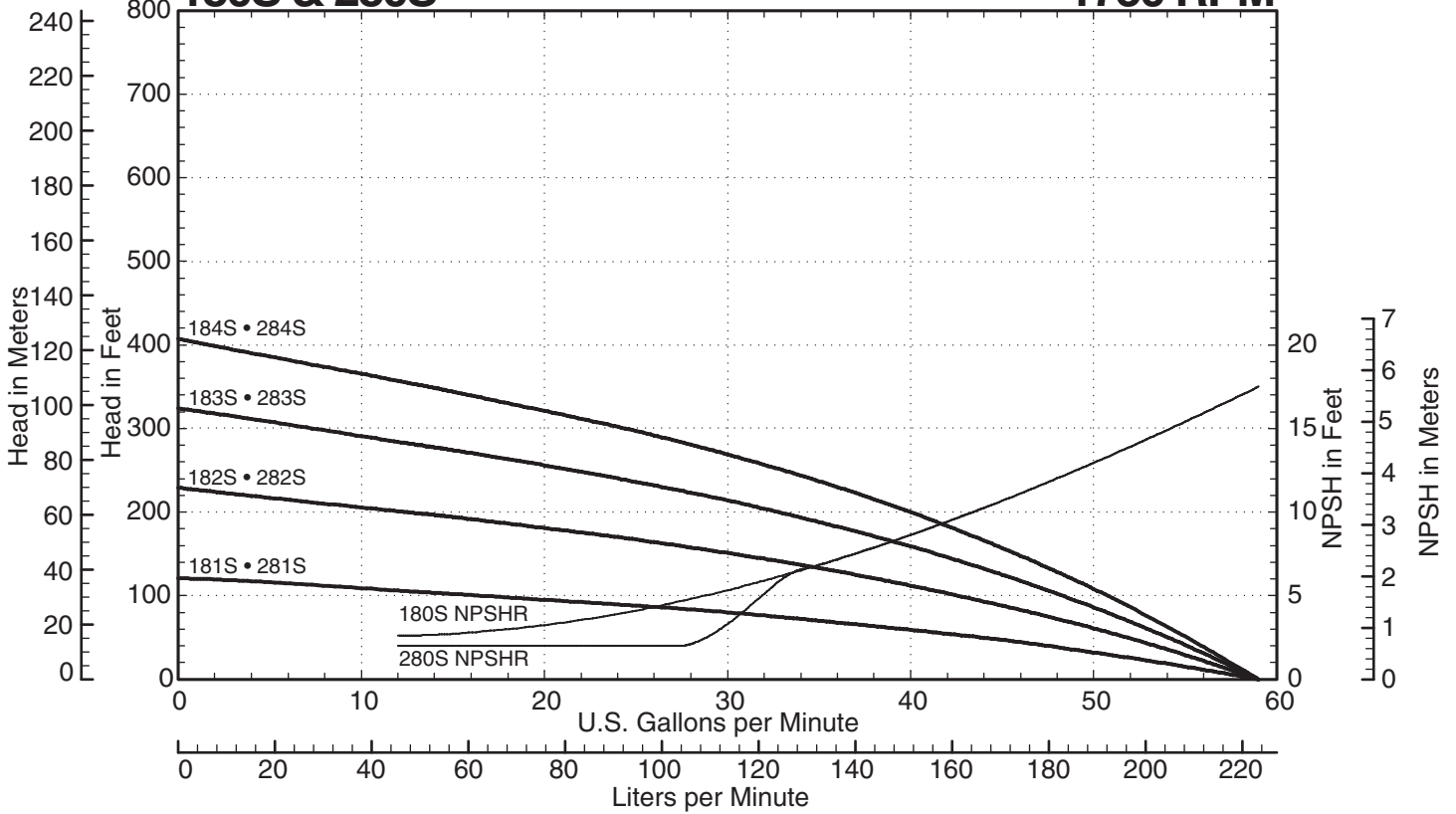

140 • 240 SERIES PUMPS

NOTES

- Consult factory for operation below 10 GPM
- *Add 1/2 horsepower for 280 Series models
- **Horsepower data is valid for 1.0 specific gravity fluids only



401 West Main Street • Plano, IL 60545-1436
 Phone: 630-552-4115 • Fax: 630-552-3688
 Email: SALES@MTHPUMPS.COM
 http://WWW.MTHPUMPS.COM



140 • 240 • 180 • 280 SERIES

Performance Curves 180S & 280S*

1450 RPM

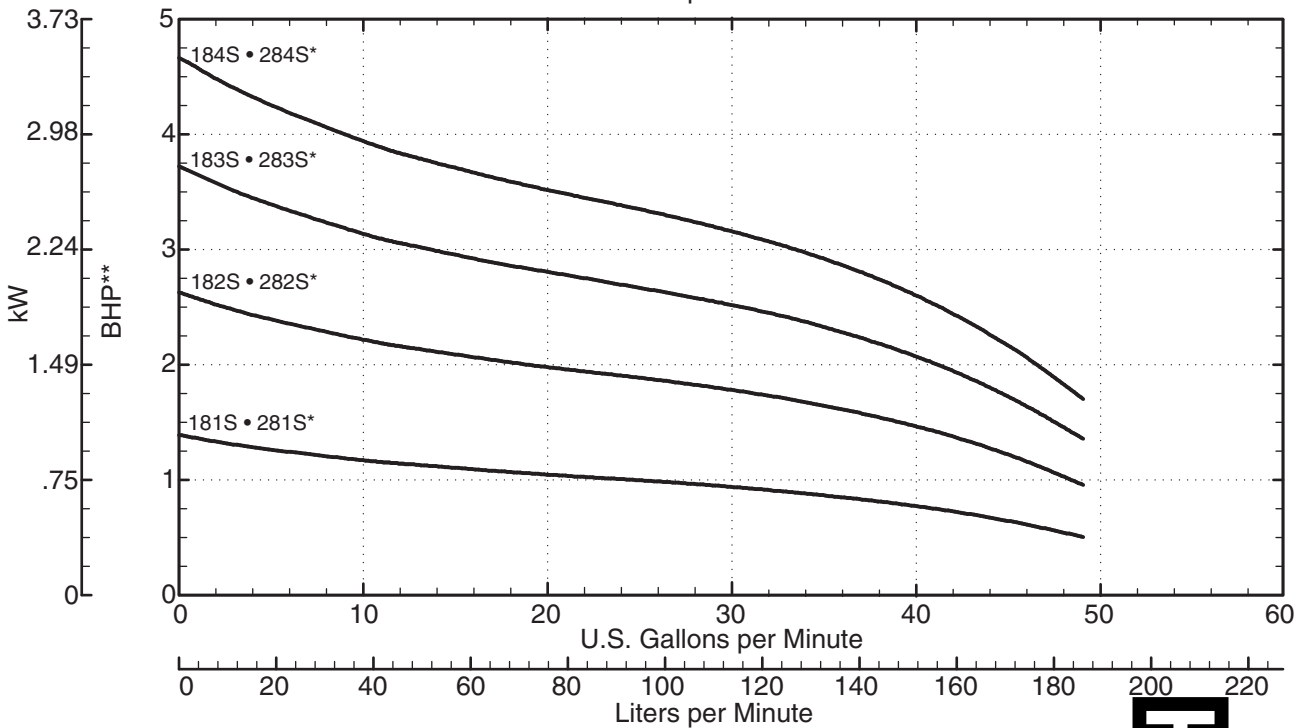
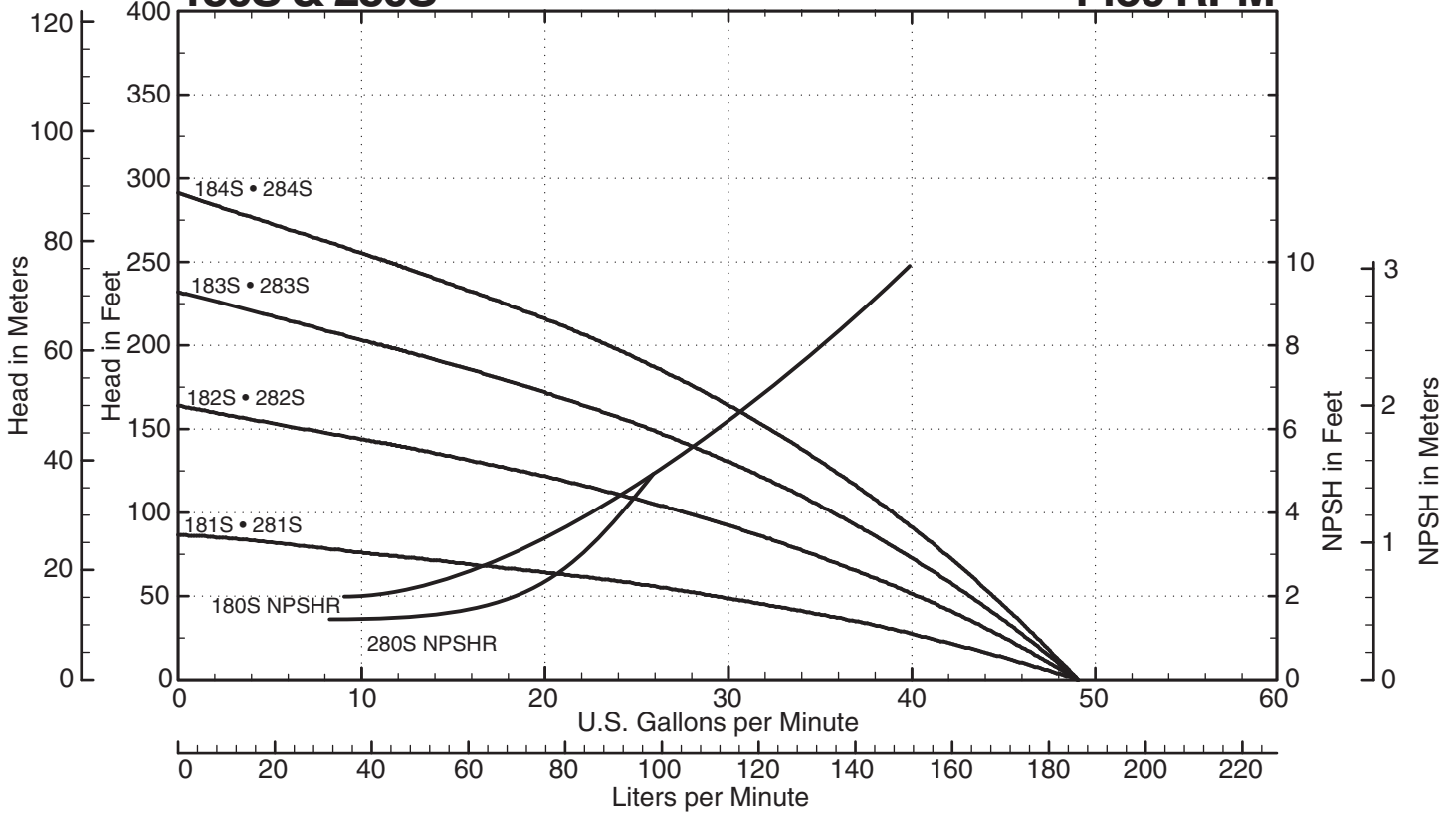

NOTES

Consult factory for operation below 10 GPM
 *Add 1/2 horsepower for 280 Series models
 **Horsepower data is valid for 1.0 specific gravity fluids only



401 West Main Street • Plano, IL 60545-1436
 Phone: 630-552-4115 • Fax: 630-552-3688
 Email: SALES@MTHPUMPS.COM
 http://WWW.MTHPUMPS.COM



140 • 240 SERIES PUMPS

Dimensions

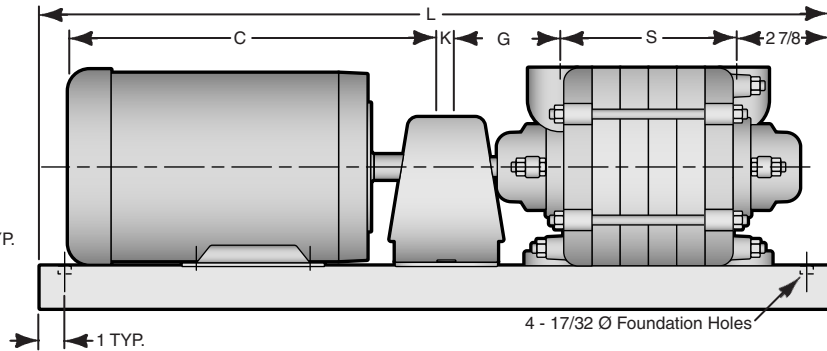
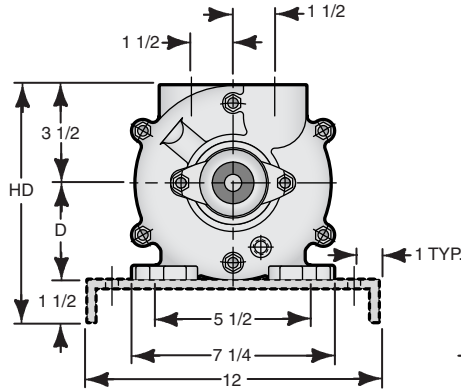
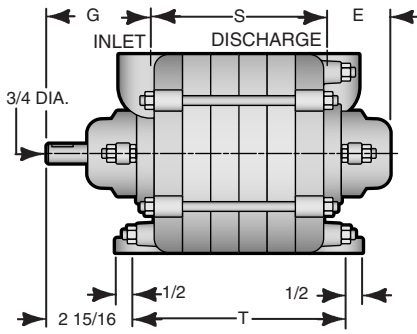

Pump Only Dimensions

PUMP SERIES	INLET	DISCHARGE	E	G	S	T
141	1 1/4" NPT	1 1/4" NPT	2 1/8	3 13/16	4 1/4	6
142	1 1/4" NPT	1 1/4" NPT	2 1/8	3 13/16	6 1/4	8
143	1 1/4" NPT	1 1/4" NPT	2 1/8	3 13/16	8 1/4	10
144	1 1/4" NPT	1 1/4" NPT	2 1/8	3 13/16	10 1/4	12
181	1 1/2" NPT	1 1/2" NPT	2 1/4	3 11/16	5 1/2	7
182	1 1/2" NPT	1 1/2" NPT	2 1/4	3 11/16	8 1/2	10
183	1 1/2" NPT	1 1/2" NPT	2 1/4	3 11/16	11 1/2	13
184	1 1/2" NPT	1 1/2" NPT	2 1/4	3 11/16	14 1/2	16

ROTATION: Clockwise when viewed from driver end.

140 Series Flex Coupled Pump Dimensions

FRAME	CPLG	ALL 140 MODELS				MODEL 141		MODEL 142		MODEL 143		MODEL 144	
		K	D	HD	C	S	L	S	L	S	L	S	L
56	3J	3/8	3 1/2	8 1/2	12	4 1/4	24	6 1/4	26	8 1/4	28	10 1/4	30
143T	4J	5/8	3 1/2	8 1/2	13	4 1/4	24	6 1/4	26	8 1/4	28	10 1/4	30
145T	4J	5/8	3 1/2	8 1/2	14	4 1/4	24	6 1/4	26	8 1/4	28	10 1/4	30
182T	5J	3/4	4 1/2	9 1/2	16	4 1/4	26	6 1/4	30	8 1/4	32	10 1/4	35
184T	5J	3/4	4 1/2	9 1/2	17	---	---	6 1/4	30	8 1/4	32	10 1/4	35
213T	6J	7/8	5 1/4	10 1/4	19	---	---	---	---	8 1/4	35	10 1/4	40
215T	6J	7/8	5 1/4	10 1/4	20	---	---	---	---	---	---	10 1/4	40

180 Series Flex Coupled Pump Dimensions

FRAME	CPLG	ALL 180 MODELS				MODEL 181		MODEL 182		MODEL 183		MODEL 184	
		K	D	HD	C	S	L	S	L	S	L	S	L
56	3J	3/8	3 1/2	8 1/2	12	5 1/2	26	8 1/2	28	11 1/2	30	14 1/2	35
143T	4J	5/8	3 1/2	8 1/2	13	5 1/2	26	8 1/2	28	11 1/2	30	14 1/2	35
145T	4J	5/8	3 1/2	8 1/2	14	5 1/2	26	8 1/2	28	11 1/2	30	14 1/2	35
182T	5J	3/4	4 1/2	9 1/2	16	5 1/2	28	8 1/2	30	11 1/2	32	14 1/2	40
184T	5J	3/4	4 1/2	9 1/2	17	5 1/2	28	8 1/2	30	11 1/2	32	14 1/2	40
213T	6J	7/8	5 1/4	10 1/4	19	---	---	8 1/2	35	11 1/2	40	14 1/2	45
215T	6J	7/8	5 1/4	10 1/4	20	---	---	8 1/2	35	11 1/2	40	14 1/2	45

140 • 240 SERIES PUMPS

NOTES

All dimensions in inches. May vary ± 1/4 inches.
 °C Dimension varies depending on motor enclosure type. Max Dimension Listed
 Not for construction purposes unless certified.
 ROTATION: Clockwise when viewed from driver end.



MTH PUMPS

401 West Main Street • Plano, IL 60545-1436
 Phone: 630-552-4115 • Fax: 630-552-3688
 Email: SALES@MTHPUMPS.COM
 http://WWW.MTHPUMPS.COM



140 • 240 • 180 • 280 SERIES

Dimensions

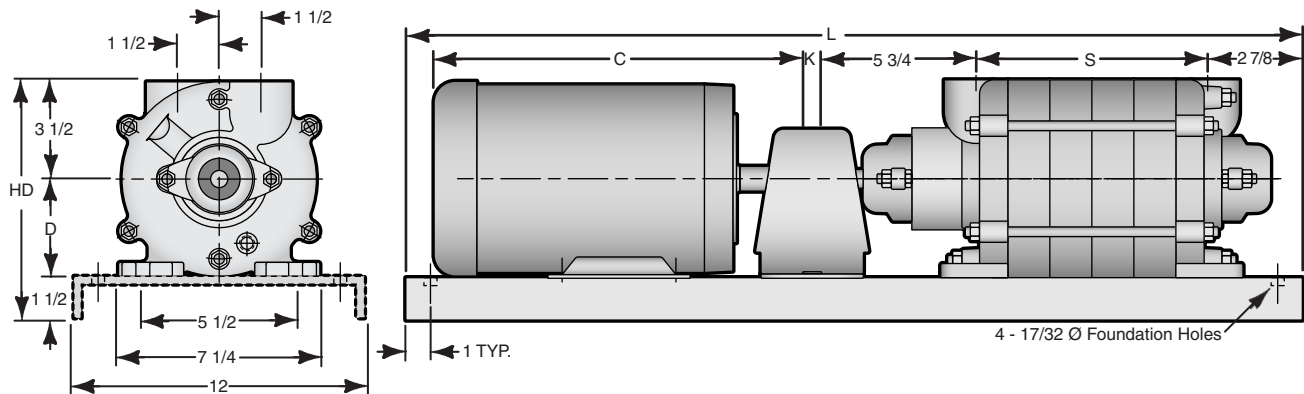
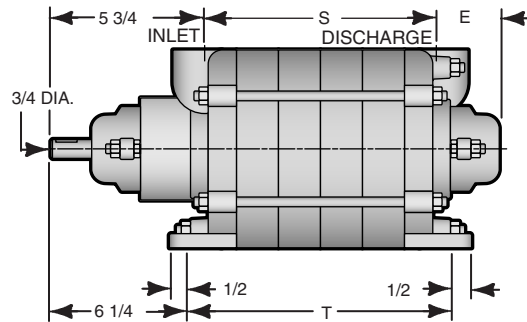

Pump Only Dimensions

PUMP SERIES	INLET	DISCHARGE	E	S	T
241	1 1/2" NPT	1 1/4" NPT	2 1/8	5 5/8	6
242	1 1/2" NPT	1 1/4" NPT	2 1/8	7 5/8	8
243	1 1/2" NPT	1 1/4" NPT	2 1/8	9 5/8	10
244	1 1/2" NPT	1 1/4" NPT	2 1/8	11 5/8	12
281	1 1/2" NPT	1 1/2" NPT	2 1/4	6 5/8	7
282	1 1/2" NPT	1 1/2" NPT	2 1/4	9 5/8	10
283	1 1/2" NPT	1 1/2" NPT	2 1/4	12 5/8	13
284	1 1/2" NPT	1 1/2" NPT	2 1/4	15 5/8	16

ROTATION: Clockwise when viewed from driver end.

240 Series Flex Coupled Pump Dimensions

FRAME	CPLG	ALL 240 MODELS				MODEL 241		MODEL 242		MODEL 243		MODEL 244	
		K	D	HD	C	S	L	S	L	S	L	S	L
56	3J	3/8	3 1/2	8 1/2	12	5 5/8	28	7 5/8	30	9 5/8	32	11 5/8	35
143T	4J	5/8	3 1/2	8 1/2	13	5 5/8	28	7 5/8	30	9 5/8	32	11 5/8	35
145T	4J	5/8	3 1/2	8 1/2	14	5 5/8	28	7 5/8	30	9 5/8	32	11 5/8	35
182T	5J	3/4	4 1/2	9 1/2	16	5 5/8	30	7 5/8	32	9 5/8	35	11 5/8	38
184T	5J	3/4	4 1/2	9 1/2	17	5 5/8	30	7 5/8	32	9 5/8	35	11 5/8	38
213T	6J	7/8	5 1/4	10 1/4	19	---	---	---	---	9 5/8	40	11 5/8	40
215T	6J	7/8	5 1/4	10 1/4	20	---	---	---	---	9 5/8	40	11 5/8	40

280 Series Flex Coupled Pump Dimensions

FRAME	CPLG	ALL 280 MODELS				MODEL 281		MODEL 282		MODEL 283		MODEL 284	
		K	D	HD	C	S	L	S	L	S	L	S	L
56	3J	3/8	3 1/2	8 1/2	12	6 5/8	28	9 5/8	32	12 5/8	35	15 5/8	38
143T	4J	5/8	3 1/2	8 1/2	13	6 5/8	28	9 5/8	32	12 5/8	35	15 5/8	38
145T	4J	5/8	3 1/2	8 1/2	14	6 5/8	28	9 5/8	32	12 5/8	35	15 5/8	38
182T	5J	3/4	4 1/2	9 1/2	16	6 5/8	30	9 5/8	35	12 5/8	38	15 5/8	40
184T	5J	3/4	4 1/2	9 1/2	17	6 5/8	30	9 5/8	35	12 5/8	38	15 5/8	40
213T	6J	7/8	5 1/4	10 1/4	19	---	---	---	---	12 5/8	40	15 5/8	42
215T	6J	7/8	5 1/4	10 1/4	20	---	---	---	---	12 5/8	40	15 5/8	42

NOTES

All dimensions in inches. May vary $\pm 1/4$ inches.
 *C Dimension varies depending on motor enclosure type. Max Dimension Listed
 Not for construction purposes unless certified.
 ROTATION: Clockwise when viewed from driver end.

401 West Main Street • Plano, IL 60545-1436
 Phone: 630-552-4115 • Fax: 630-552-3688
 Email: SALES@MTHPUMPS.COM
 http://WWW.MTHPUMPS.COM

WARNING:
 CANCER AND REPRODUCTIVE HARM
 WWW.P65WARNINGS.CA.GOV